

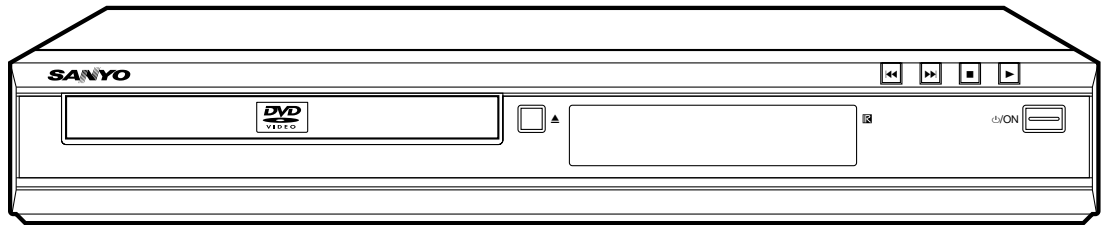

INSTRUCTION MANUAL

DVD-SL25

DVD Player

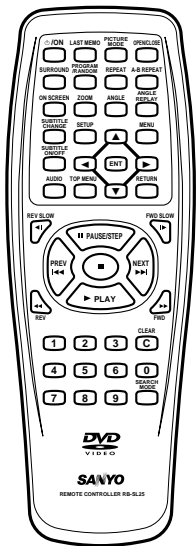

CONTENTS

Accessories	E1	Picture Zoom (Pin Point Zoom) [DVD]	E18
Controls	E3	Viewing from a Desired Camera Angle (Multi-Angle) [DVD]	E18
Remote Control	E4	Angle Replay	E18
Before Connection	E5	Repeat Playback	E19
Choosing a Connection	E5	Designated Range Repeat Playback (A-B Repeat)	E19
Basic Connections	E6	Random Playback [CD]	E20
Connecting to a Conventional TV (Example 1)	E6	Programmed Playback [CD]	E20
Connecting to a TV with Progressive-scan Capability (Example 2)	E8	Selecting Subtitle Language [DVD]	E21
Additional Connection Examples	E9	Selecting Audio Soundtrack Language (Multi-Language) [DVD]	E21
Connecting to an Audio System and TV (Example 3)	E9	Selecting On-Screen Information	E22
Connecting to an Amplifier with Dolby Digital Decoder, DTS Decoder, or MPEG2 Decoder (Example 4)	E10	Selecting Picture Mode	E22
Connecting to a Digital Amplifier (Example 5)	E10	Selecting Spatializer N-2-2™ Virtual Surround Sound Mode [DVD] [CD]	E22
Connecting to an Amplifier with Dolby Pro Logic Decoder (Example 6)	E11	MP3/WMA CD Operation	E23
Power Supply	E11	Before Starting	E23
For Safe and Efficient Operation	E11	MP3/WMA CD Playback	E23
Playable Discs	E12	Stopping Playback	E24
Basic Operation	E13	Pause	E24
Preparations	E13	File Skip	E24
Basic Playback	E13	Repeat Playback	E24
Stopping Playback	E14	Picture Disc Operation	E25
Continuing Playback from Where You Stopped Watching (LAST MEMO PLAY), for DVD only	E14	KODAK Picture CD Playback	E25
Selecting a DVD Menu	E15	JPEG CD Playback	E26
Selecting a Top Menu [DVD]	E15	Picture Zoom	E26
Chapter (Track) Skip	E15	Initial Settings	E27
Title Search [DVD]	E16	Setting Language	E27
Chapter Search [DVD]	E16	Setting Display	E28
Time Search [DVD]	E16	Setting Digital Out	E29
Time Search [CD]	E16	Setting Parental	E30
Track Search [CD]	E16	Language Code List	E31
Fast Playback	E17	Troubleshooting Guide	E32
Slow Motion Playback [DVD]	E17	Maintenance	E33
Still Picture (Pause)	E17	Specifications	E33
Frame by Frame Advance Playback [DVD]	E17	Warranty	E34

ACCESSORIES



RB-SL25 wireless remote control

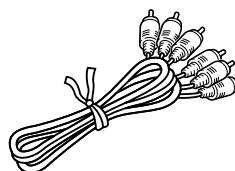



Audio/Video cable

	CAUTION RISK OF ELECTRIC SHOCK DO NOT OPEN	
CAUTION: TO PREVENT THE RISK OF ELECTRIC SHOCK, DO NOT REMOVE COVER (OR BACK). NO USER-SERVICEABLE PARTS INSIDE. REFER SERVICING TO QUALIFIED SERVICE PERSONNEL.		

WARNING: TO PREVENT FIRE OR SHOCK HAZARD, DO NOT EXPOSE THIS APPLIANCE TO RAIN OR MOISTURE.

CAUTION - USE OF CONTROLS OR ADJUSTMENTS OR PERFORMANCE OF PROCEDURES OTHER THAN THOSE SPECIFIED HEREIN MAY RESULT IN HAZARDOUS RADIATION EXPOSURE.

THIS UNIT SHOULD NOT BE ADJUSTED OR REPAIRED BY ANYONE EXCEPT PROPERLY QUALIFIED SERVICE PERSONNEL.

	This symbol indicates that dangerous voltage constituting a risk of electric shock is present within this unit.
	This symbol indicates that there are important operating and maintenance instructions in the literature accompanying this unit.

WARNING: UNAUTHORIZED RECORDING OF COPYRIGHTED MATERIAL MAY VIOLATE APPLICABLE COPYRIGHT LAWS. THE MANUFACTURER ASSUMES NO RESPONSIBILITY FOR UNAUTHORIZED DUPLICATION, USE OR OTHER ACTS WHICH INFRINGE UPON THE RIGHTS OF COPYRIGHT OWNERS.

THIS CLASS B DIGITAL APPARATUS COMPLIES WITH CANADIAN ICES-003.

Please Read This Manual.

Because DVD is a new technology, we recommend that you read this manual carefully before connecting your DVD video player and operating it for the first time.

Keep the manual in a safe place for future reference.

IMPORTANT INFORMATION:

To connect this unit to a TV, TV must have a set of Audio/Video composite input jacks (RCA-type). You cannot use an antenna terminal to connect this unit.

To enjoy Dolby Digital sound

For connection, see "Connecting to an Amplifier with Dolby Digital Decoder, DTS Decoder or MPEG2 Decoder (Example 4)" on page E10.

See "Setting Digital Out" in the INITIAL SETTINGS on page E29.

CONTROLS

Front Panel

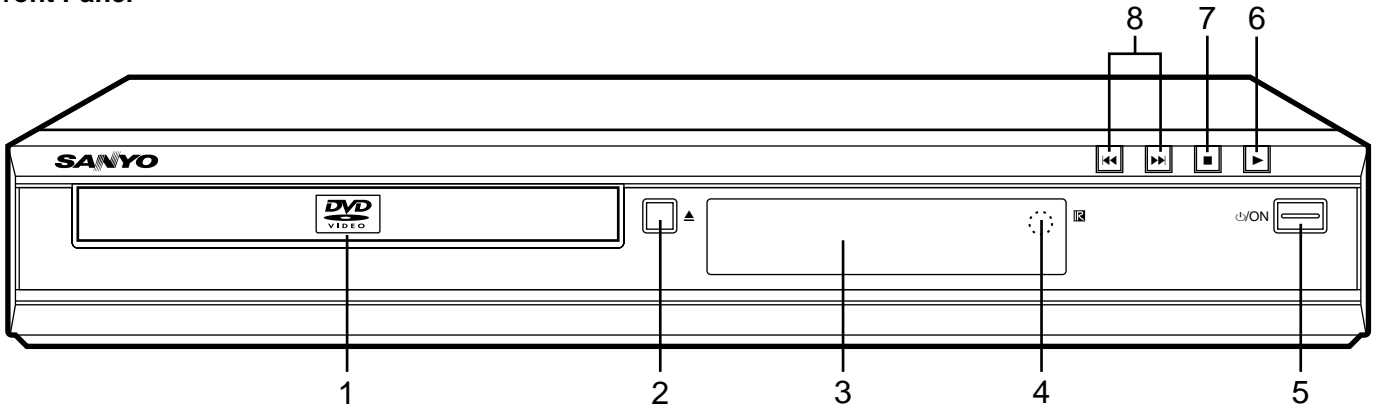

- | | |
|--------------------------|--------------------------------------|
| 1. Disc tray | 5. Power button (⏻/ON) |
| 2. Open/Close button (⏏) | 6. Play button (▶) |
| 3. FL display | 7. Stop button (■) |
| 4. Remote sensor (IR) | 8. Skip/Next/Previous buttons (⏮, ⏭) |

FL Display

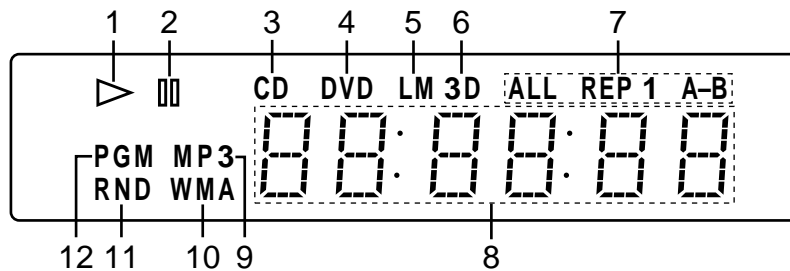

- | | |
|---|---|
| 1. Play indicator (▶) | 8. Message or number indicators
(Title, chapter, track, playing time or other information) |
| 2. Pause indicator (⏸) | 9. MP3 indicator (MP3) |
| 3. CD indicator (CD) | 10. WMA indicator (WMA) |
| 4. DVD indicator (DVD) | 11. Random play indicator (RND) |
| 5. Last memory indicator (LM) | 12. Program indicator (PGM) |
| 6. Virtual Surround Sound indicator (3D) | |
| 7. Repeat mode indicators (ALL, REP 1, A-B) | |

Rear Panel

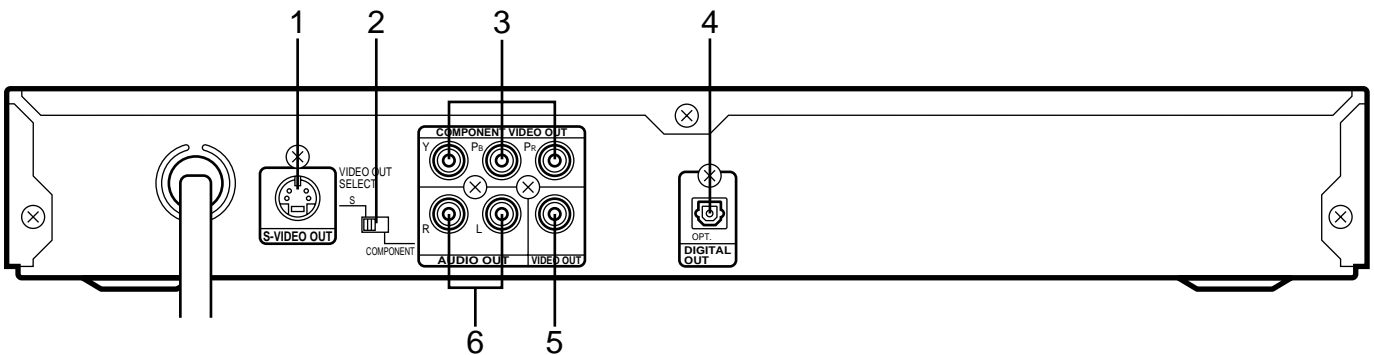

- | | |
|---|--|
| 1. S-Video output jack (S-VIDEO OUT) | 4. Optical digital output jack (DIGITAL OUT) |
| 2. Video output select switch (VIDEO OUT SELECT) | 5. Video output jack (VIDEO OUT) |
| 3. Component video output jacks (COMPONENT VIDEO OUT) | 6. Audio output jacks (AUDIO OUT) |

REMOTE CONTROL

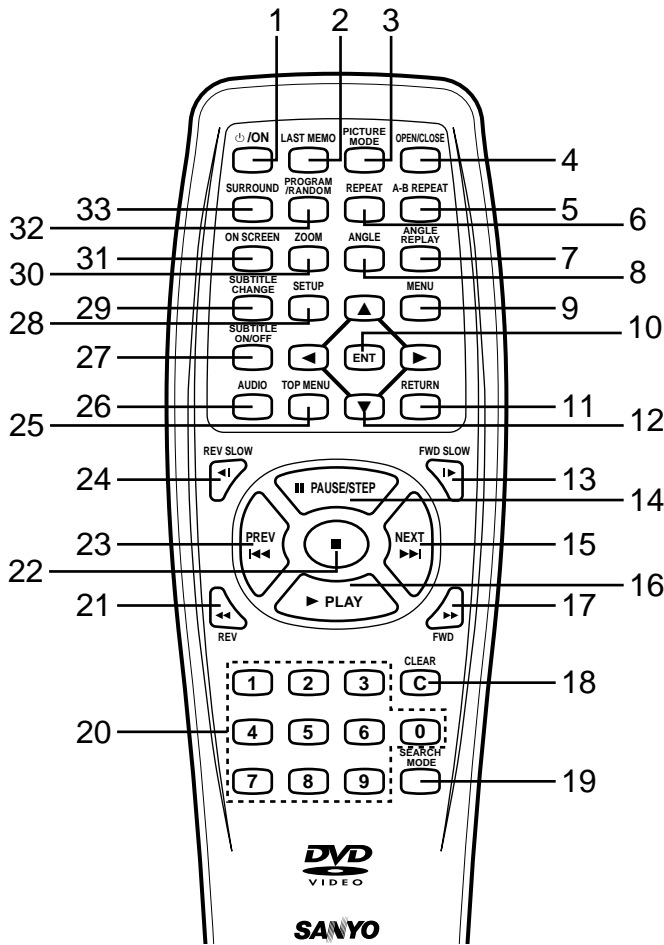

Controls

1. Power button (ON/OFF)
2. Last memory button (LAST MEMO)
3. Picture mode button (PICTURE MODE)
4. Open/Close button (OPEN/CLOSE)
5. A-B repeat button (A-B REPEAT)
6. Repeat button (REPEAT)
7. Angle replay button (ANGLE REPLAY)
8. Angle button (ANGLE)
9. Menu button (MENU)
10. Enter button (ENT)
11. Return button (RETURN) (See page E24.)
12. Directional arrow buttons (▲, ►, ▼, ◀)
13. Forward slow button (FWD SLOW ►|)
14. Pause/Step button (|| PAUSE/STEP)
15. Skip/Next button (NEXT ►►|)
16. Play button (► PLAY)
17. Forward button (FWD ►►)
18. Clear button (CLEAR)
19. Search mode button (SEARCH MODE)
20. Number buttons (1 - 9, 0)
21. Reverse button (REV ◀◀)
22. Stop button (■)
23. Skip/Previous button (PREV ◀◀|)
24. Reverse slow button (REV SLOW ◀|)
25. Top menu button (TOP MENU)
26. Audio button (AUDIO)
27. Subtitle On/Off button (SUBTITLE ON/OFF)
28. Setup button (SETUP)
29. Subtitle change button (SUBTITLE CHANGE)
30. Zoom button (ZOOM)
31. On screen display button (ON SCREEN)
32. Program/Random play button (PROGRAM/RANDOM)
33. Surround sound button (SURROUND)

Inserting batteries

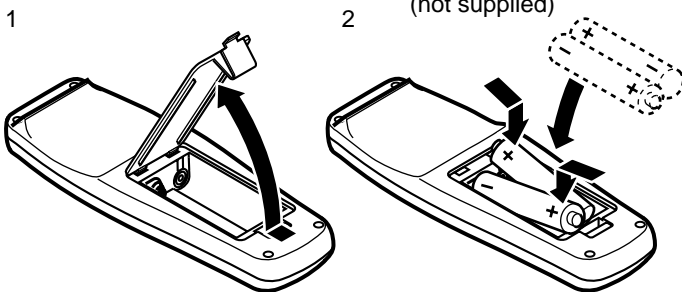

Note:
Remove the batteries if the remote control is not to be used for a month or more. Batteries left in the unit may leak and cause damage.

IMPORTANT NOTE:

SPENT OR DISCHARGED BATTERIES MUST BE RECYCLED OR DISPOSED OF PROPERLY IN COMPLIANCE WITH ALL APPLICABLE LAWS. FOR DETAILED INFORMATION, CONTACT YOUR LOCAL COUNTY SOLID WASTE AUTHORITY.

Remote control range

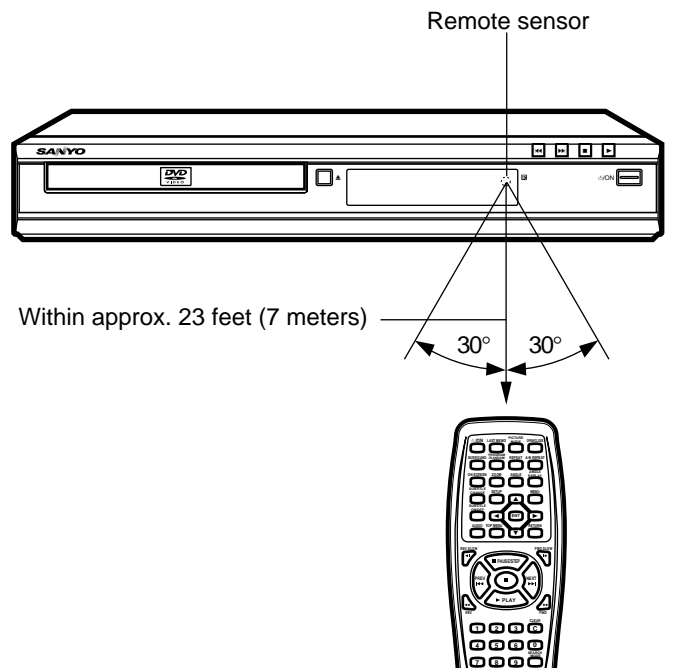

BASIC CONNECTIONS

Connecting to a Conventional TV (Example 1)

Connect the DVD video player to your TV.

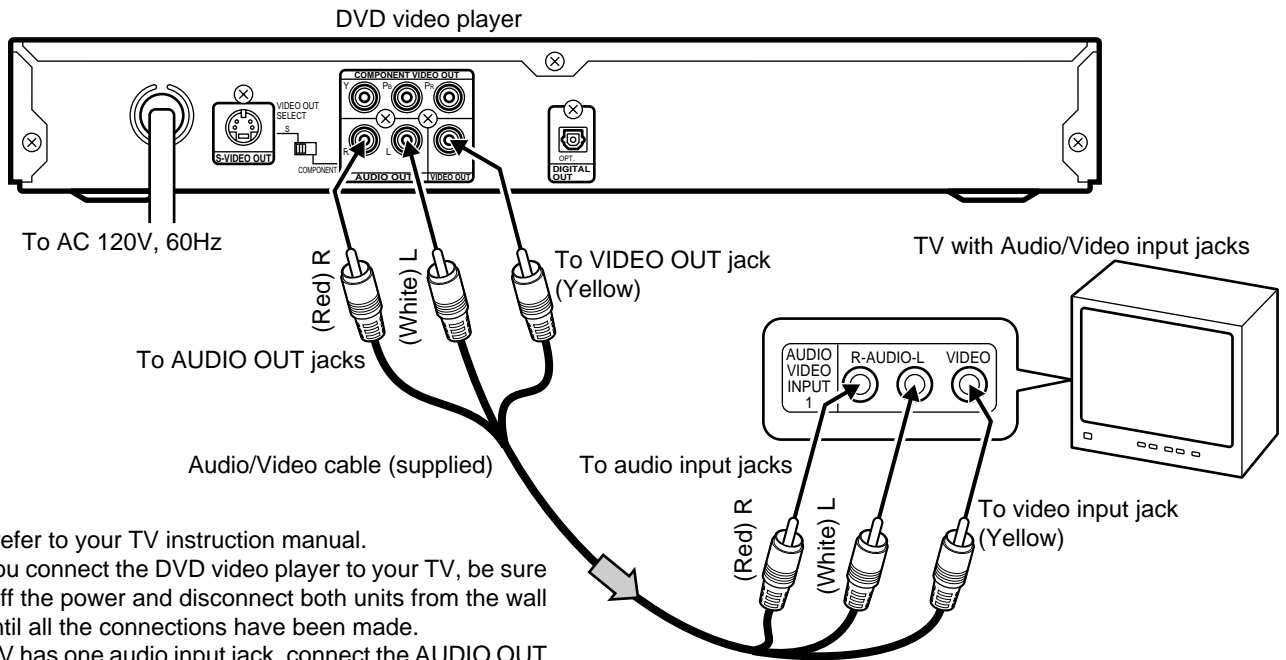

Notes:

- Please refer to your TV instruction manual.
- When you connect the DVD video player to your TV, be sure to turn off the power and disconnect both units from the wall outlet until all the connections have been made.
- If your TV has one audio input jack, connect the AUDIO OUT jacks of the DVD video player to a Y-cable adapter (not supplied), then connect it to the TV Audio input. Please consult your local audio/video dealer.
- Do not connect the DVD video player to a VCR directly. The playback picture will be distorted because DVD video discs are copy protected.

Using the S-VIDEO jack

Note:

Please follow the steps before turn on the power.

1. If your TV has the S-video input jack, connect the DVD video player with the S-video cable (not supplied). (The VIDEO OUT jack connection is not necessary.) You can enjoy clearer picture playback.
2. Set the VIDEO OUT SELECT switch to the **S** position.
3. You also need to connect the left and right audio cables (not supplied) to the AUDIO OUT jacks of DVD video player and the Audio input jacks of the TV.

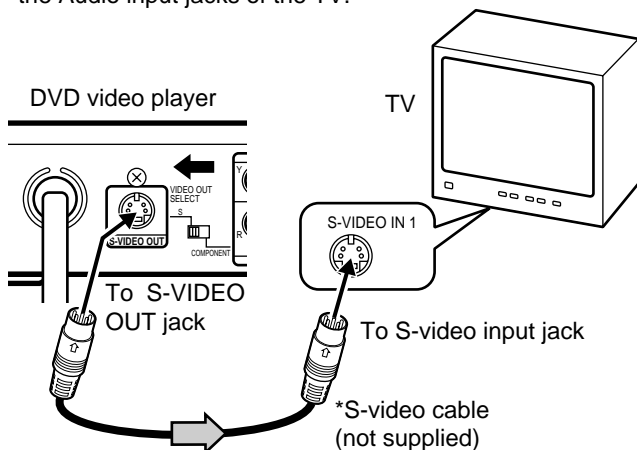

*Please consult your local audio/video dealer.

Using the COMPONENT VIDEO OUT jacks

Note:

Please follow the steps before turn on the power.

1. If your TV has the component video input jacks, connect the DVD video player to these jacks. (The VIDEO OUT or S-VIDEO OUT jack connection is not necessary.) You can enjoy high quality picture playback.
2. Set the VIDEO OUT SELECT switch to the **COMPONENT** position.
3. You also need to connect the left and right audio cables (not supplied) to the AUDIO OUT jacks of DVD video player and the Audio input jacks of the TV.
4. **Set the DVD video player to the INTERLACE position. See page E13.**

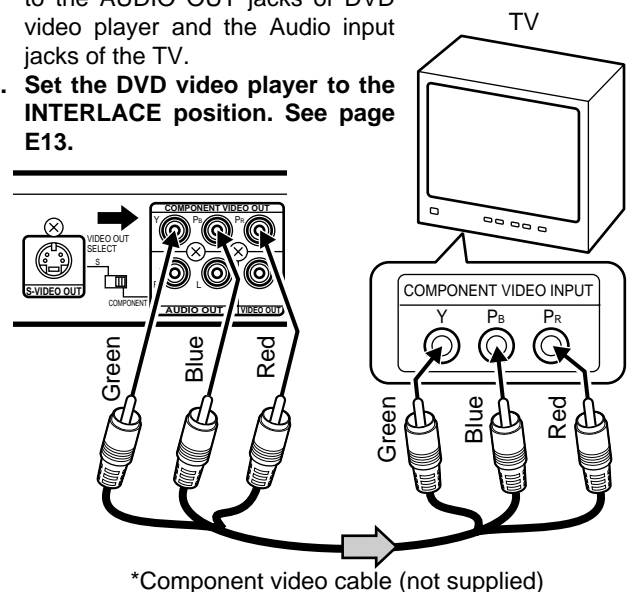

*Component video cable (not supplied)

Using RF Modulator

If your TV does not have a Video input jack and has an antenna terminal only, please purchase the *RF Modulator (not supplied). (*Please consult your audio/video dealer.)

Example: DVD video player, TV and RF Modulator connections

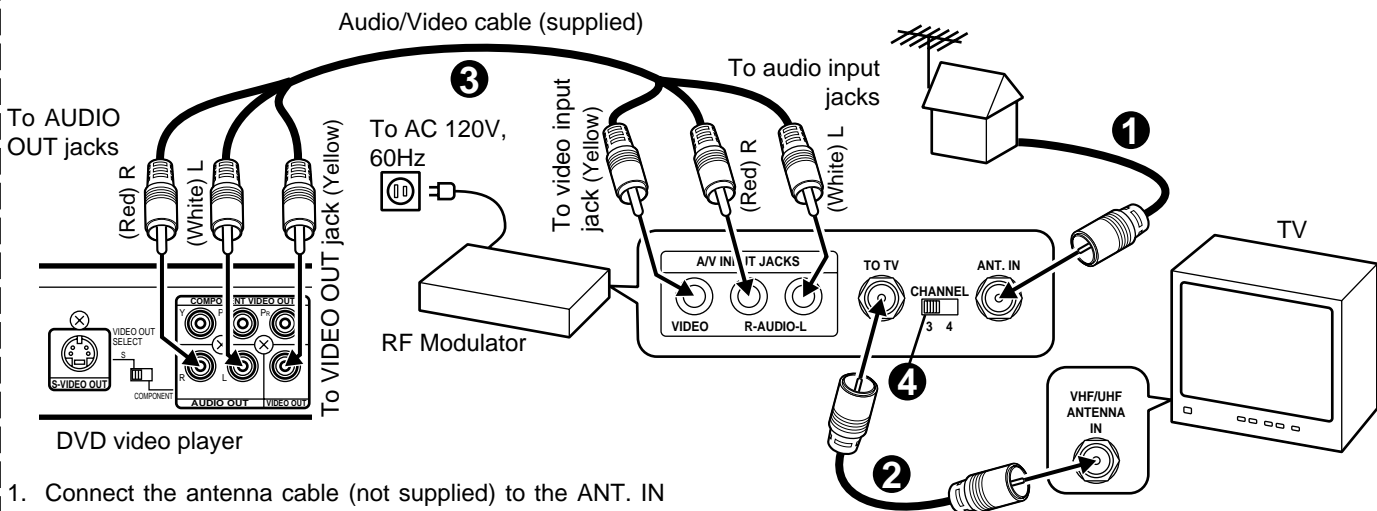

1. Connect the antenna cable (not supplied) to the ANT. IN terminal of the RF Modulator.
2. Connect the 75-ohm coaxial cable (not supplied) between the TO TV terminal of the RF Modulator and the VHF/UHF ANTENNA IN terminal of the TV.
3. Connect the Audio/Video cable (supplied) between the AUDIO OUT and VIDEO OUT jacks of the DVD video player and the AUDIO INPUT and VIDEO INPUT jacks of the RF Modulator.

4. Turn on the TV, and set the channel number (CHANNEL3 or CHANNEL4) on both TV and RF Modulator, whichever is not used for regular broadcasts in your area.

Note:
For more details, please refer to the instruction manual of the RF Modulator.

Example: DVD video player, VCR, TV and RF Modulator connections

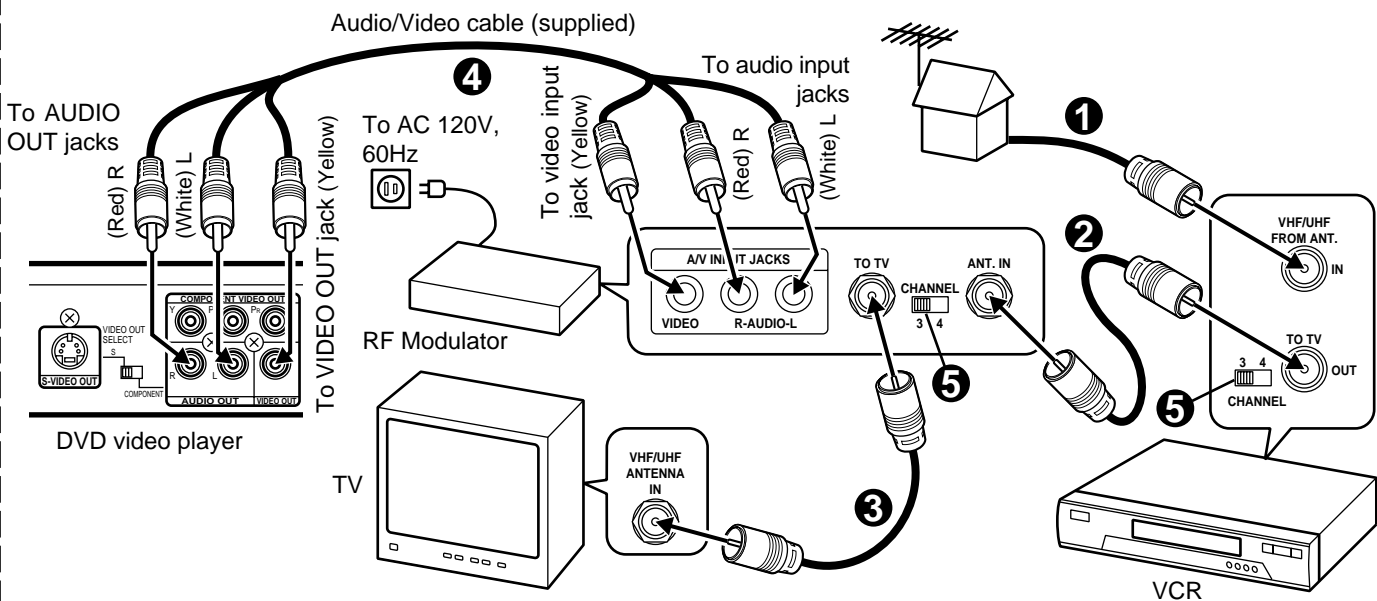

1. Connect the antenna cable (not supplied) to the VHF/UHF FROM ANT IN terminal of the VCR.
2. Connect the 75-ohm coaxial cable (not supplied) between the TO TV terminal of the VCR and the ANT. IN terminal of the RF Modulator.
3. Connect the 75-ohm coaxial cable (not supplied) between the TO TV terminal of the RF Modulator and the VHF/UHF ANTENNA IN terminal of the TV.

4. Connect the Audio/Video cable (supplied) between the AUDIO OUT and VIDEO OUT jacks of the DVD video player and the AUDIO INPUT and VIDEO INPUT jacks of the RF Modulator.
5. Turn on the TV, and set the channel number (CHANNEL3 or CHANNEL4) on all TV, VCR and RF Modulator, whichever is not used for regular broadcasts in your area.

Note:
For more details, please refer to the instruction manual of the RF Modulator.

Connecting to a TV with Progressive-scan Capability (Example 2)

Your TV must be capable of handling progressive scanning and have component video input capability.

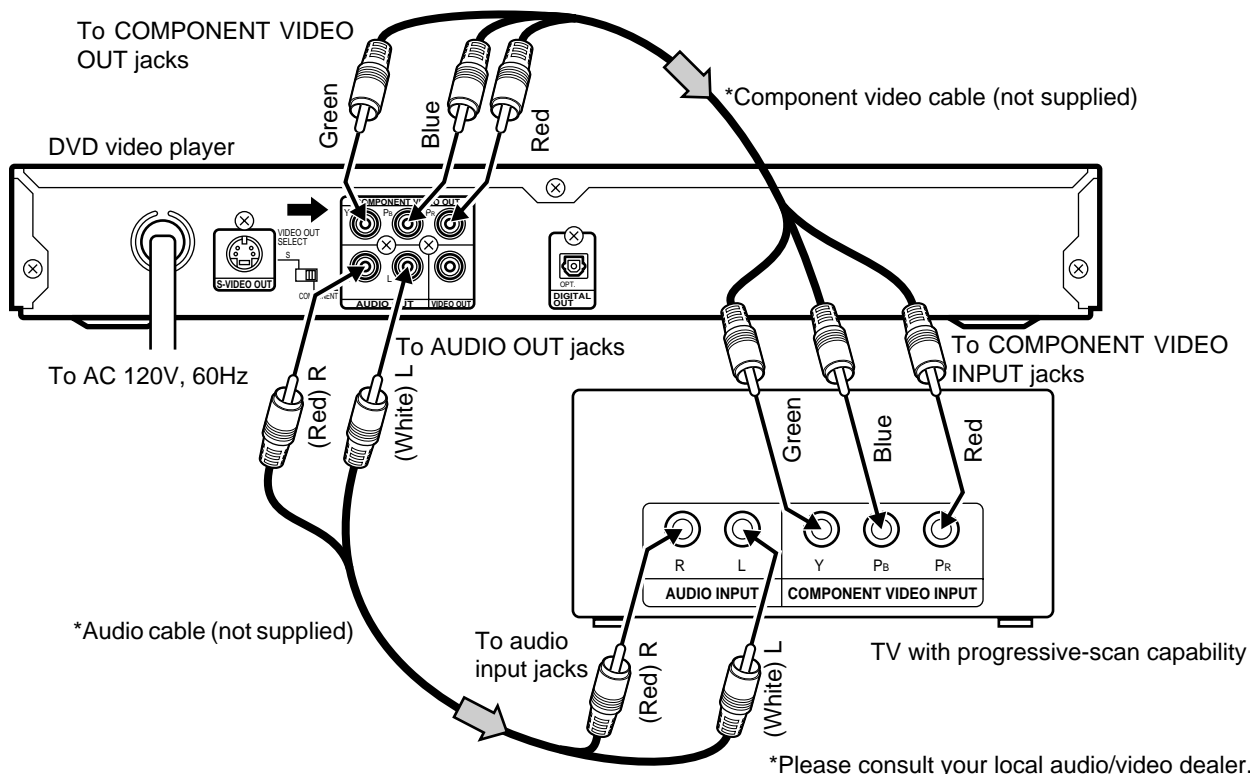

1. Connect the DVD video player to the component video input jacks of the TV. (The VIDEO OUT or S-VIDEO OUT jack connection is not necessary.)
2. Set the VIDEO OUT SELECT switch to the **COMPONENT** position.
3. You also need to connect the left and right audio cables (not supplied) to the AUDIO OUT jacks of DVD video player and the Audio input jacks of the TV.
4. **Set the DVD video player to the PROGRESSIVE position. See page E13.**

Notes:

- Please refer to your TV instruction manual.
- When you connect the DVD video player to your TV, be sure to turn off the power and disconnect both units from the wall outlet until all the connections have been made.
- Do not connect the DVD video player to a VCR directly. The playback picture will be distorted because DVD video discs are copy protected.

Progressive Scanning

While interlaced scanning produces one frame of video in two fields, progressive scanning creates one frame in one field. Conventional interlaced scanning constitutes one second with 30 frames (60 fields), but progressive scanning constitutes it with 60 frames from scratch. Progressive scanning can reproduce sharper picture with high resolution for still image or other picture containing long texts or horizontal lines.

This model has compliance with 525p (progressive) system.

Interlaced scanning

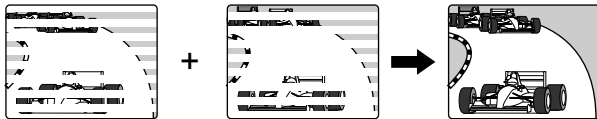

Progressive scanning

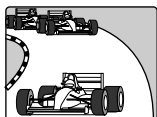

ADDITIONAL CONNECTION EXAMPLES

Connecting to an Audio System and TV (Example 3)

Connect the DVD video player to an Audio System and a TV.

DVD video player

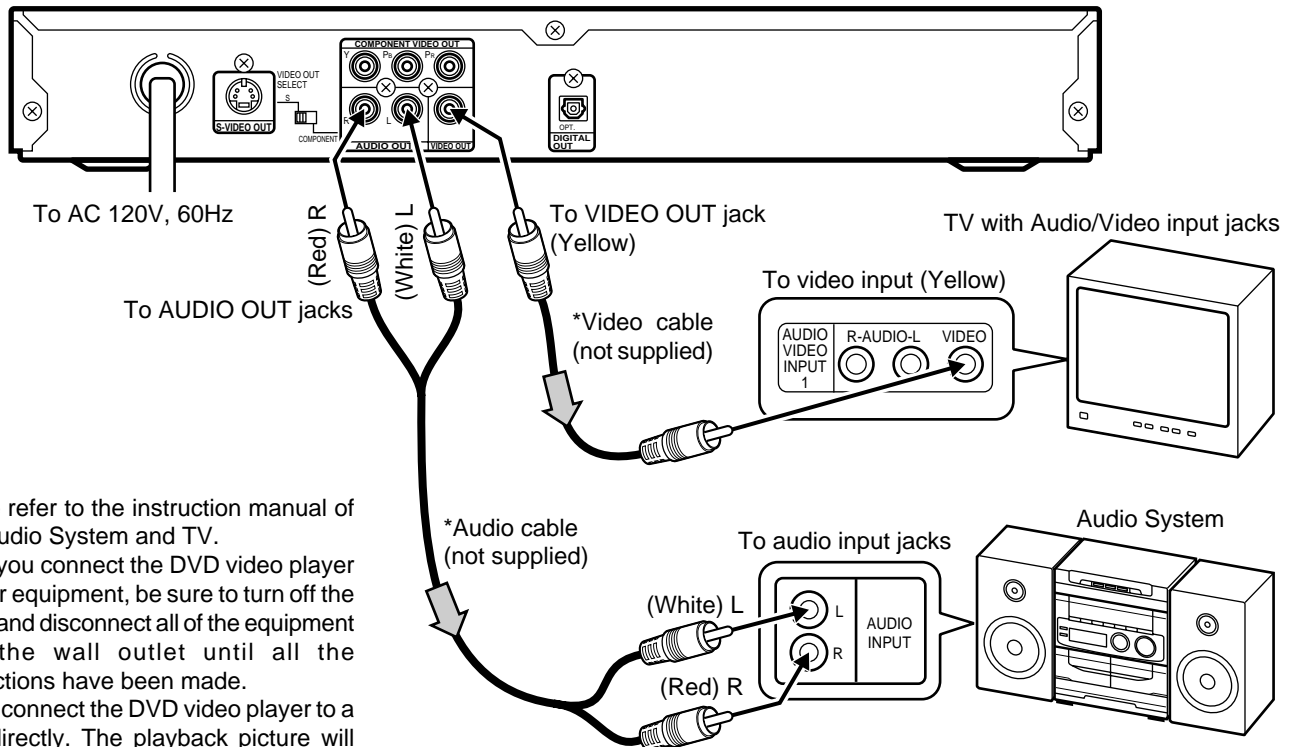

Notes:

- Please refer to the instruction manual of your Audio System and TV.
- When you connect the DVD video player to other equipment, be sure to turn off the power and disconnect all of the equipment from the wall outlet until all the connections have been made.
- Do not connect the DVD video player to a VCR directly. The playback picture will be distorted because DVD video discs are copy protected.

*Please consult your local audio/video dealer.

Using the S-VIDEO jack

Note:

Please follow the steps before turn on the power.

1. If your TV has the S-video input jack, connect the DVD video player with the S-video cable (not supplied). (The VIDEO OUT jack connection is not necessary.) You can enjoy clearer picture playback.
2. Set the VIDEO OUT SELECT switch to the **S** position.
3. You also need to connect the left and right audio cables (not supplied) to the AUDIO OUT jacks of DVD video player and the Audio input jacks of the Audio System.

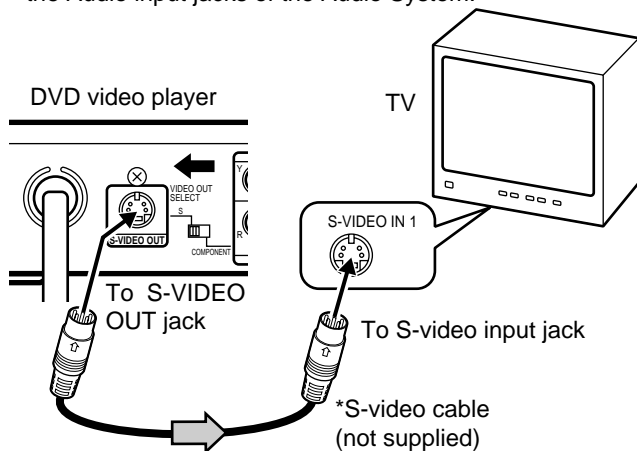

*Please consult your local audio/video dealer.

Using the COMPONENT VIDEO OUT jacks

Note:

Please follow the steps before turn on the power.

1. If your TV has the component video input jacks, connect the DVD video player to these jacks. (The VIDEO OUT or S-VIDEO OUT jack connection is not necessary.) You can enjoy high quality picture playback.
2. Set the VIDEO OUT SELECT switch to the **COMPONENT** position.
3. You also need to connect the left and right audio cables (not supplied) to the AUDIO OUT jacks of DVD video player and the Audio input jacks of the Audio System.
4. **Set the DVD video player to the INTERLACE position. See page E13.**

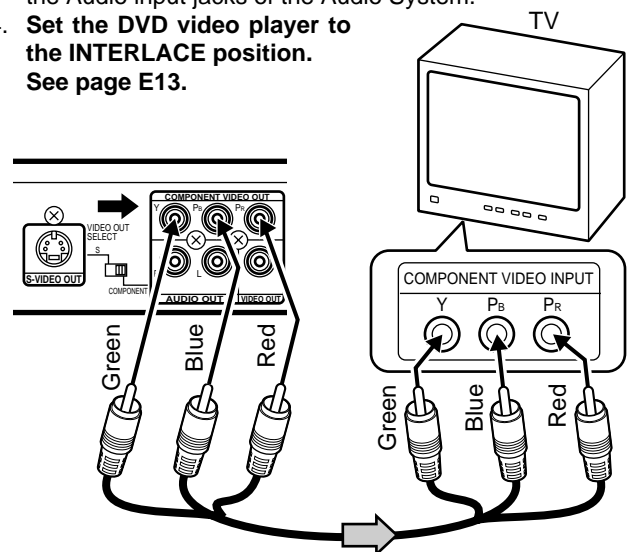

*Component video cable (not supplied)

Notes:

- For VIDEO connection, please refer to “BASIC CONNECTIONS”.
- Please refer to the instruction manual of your amplifier.
- When you connect the DVD video player to your amplifier, be sure to turn off the power and disconnect both units from the wall outlet until all the connections have been made.

Connecting to an Amplifier with Dolby Digital Decoder, DTS Decoder or MPEG2 Decoder (Example 4)

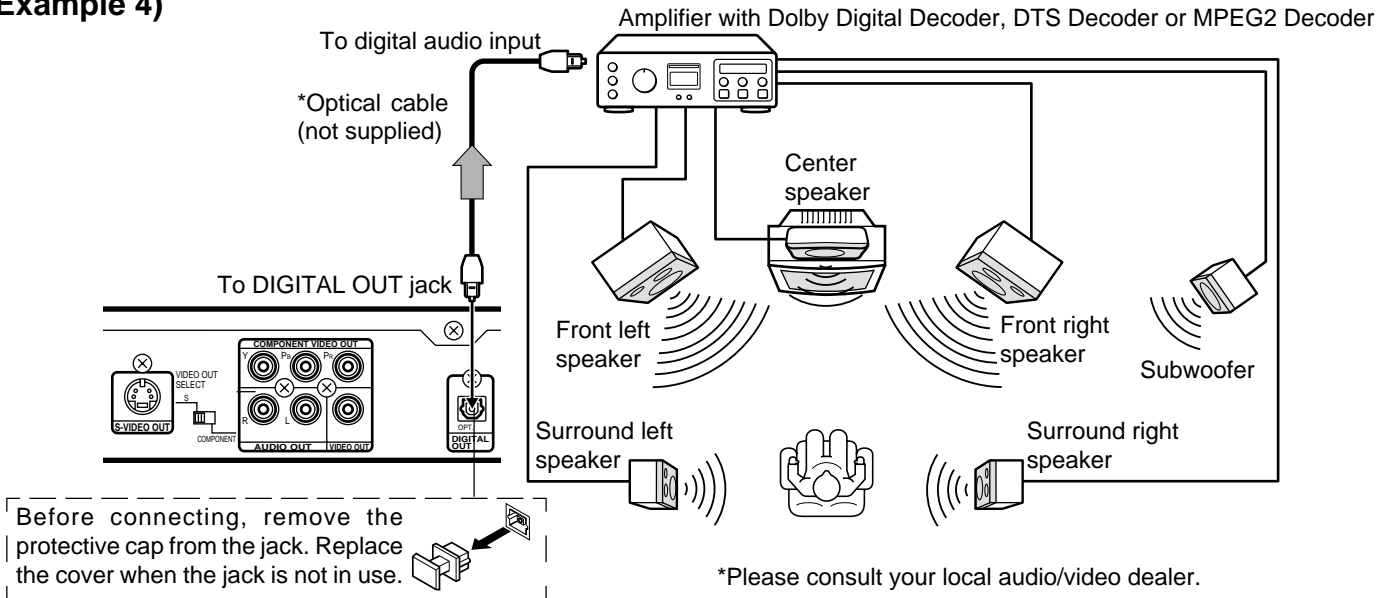

*Please consult your local audio/video dealer.

To enjoy Dolby Digital sound

Select “Dolby Digital BitStream” in “Setting Digital Out” on the INITIAL SETTINGS. (See page E29.)

Manufactured under license from Dolby Laboratories.

“Dolby”, “Pro Logic” and the double-D symbol are trademarks of Dolby Laboratories.

To enjoy DTS sound

Select “DTS On” in “Setting Digital Out” on the INITIAL SETTINGS. (See page E29.)

“DTS” and “DTS Digital Out” are trademarks of Digital Theater Systems, Inc.

To enjoy MPEG2 sound

Select “MPEG BitStream” in “Setting Digital Out” on the INITIAL SETTINGS. (See page E29.)

Connecting to a Digital Amplifier (Example 5)

You can enjoy 2 Channel Digital Stereo Sound.

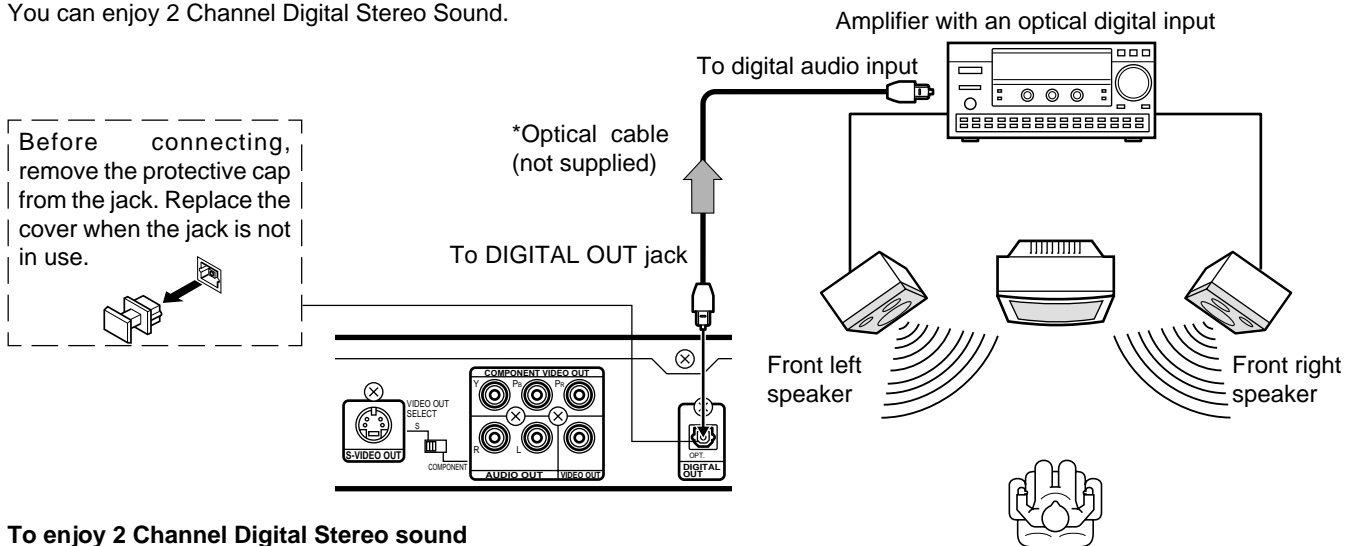

To enjoy 2 Channel Digital Stereo sound

Select “Dolby Digital LPCM”, “MPEG LPCM”, and “DTS Off” in “Setting Digital Out” on the INITIAL SETTINGS. (See page E29.)

Note:

If “DTS On” is selected, loud noise will occur. (See page E29.)

*Please consult your local audio/video dealer.

Connecting to an Amplifier with Dolby Pro Logic Decoder (Example 6)

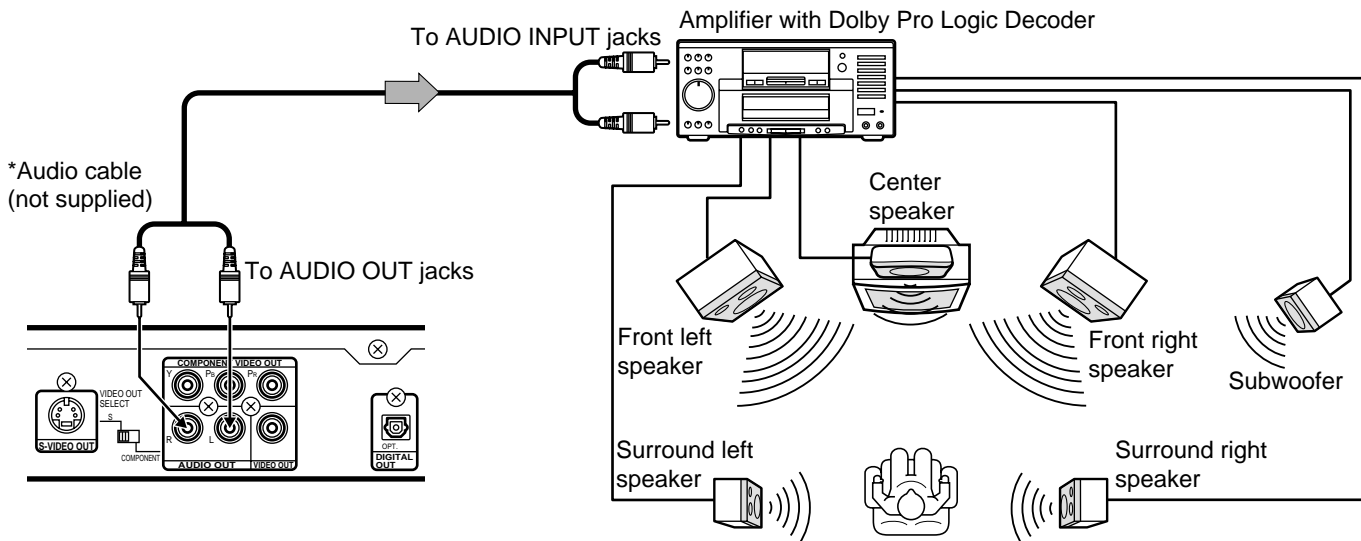

Note:

Please refer to your amplifier instruction manual.

*Please consult your local audio/video dealer.

Power Supply

Connect the power cord to a 120VAC 60Hz outlet. This unit is equipped with a polarized plug. If you have difficulty inserting the plug, turn it over and reinsert it. If the unit will not be used for a long time, disconnect the AC plug from the AC outlet.

Notes:

- Before plugging the power cord into an AC outlet, make sure that all the connections have been made.
- The unit is not disconnected from the AC power unless the power cord is unplugged from the AC outlet.

CAUTION:

TO PREVENT ELECTRIC SHOCK, MATCH WIDE BLADE OF PLUG TO WIDE SLOT, FULLY INSERT.



FOR SAFE AND EFFICIENT OPERATION

- Do not damage the power cord.
- When not in use, disconnect the power cord from the outlet. Grasp the plug, not the cord, when disconnecting the unit.
- If water should enter the unit, electrical shock or a malfunction may result. Use in an area where there is low humidity and little dust.
- Do not disassemble or alter the unit in any way.
- Do not use the unit in areas where extremes in temperature occur (below 40°F (5°C) or exceeding 95°F (35°C)), or where it may be exposed to direct sunlight.
- Because of the DVD video player extremely low noise and wide dynamic range, there is a tendency to set the volume on the amplifier higher than necessary. Doing so may produce an excessively high output from the amplifier which can cause damage to your speakers. Please be careful in this regard.
- Sudden changes in the surrounding temperature can cause dew to form on the optical pickup lens inside the unit. Under this condition the unit may be unable to operate properly. If this should occur, remove the disc and allow the unit to adjust to the surrounding temperature.
- When carrying the unit, be sure to remove a disc which may be inside and turn the power off. Then unplug the power cord from the AC outlet after 10 seconds. Carrying the unit with a disc inside may damage the disc and/or the unit.
- The unit is automatically set to the Screen Saver mode after approximately 15 minutes have elapsed under the stop or pause mode.
- The unit is automatically set to the standby mode after approximately 30 minutes have elapsed under the complete stop mode.

Press **[▲]** (or [OPEN/CLOSE] on the remote control) when closing the disc tray. Do not push the disc tray.

PLAYABLE DISCS

The following types of discs can be played on this unit.

Disc type and logo mark	
DVD-Video	
Audio CD	

Region Number

Region number (Regional restriction code) is built-in to the unit and DVD video discs.

Region number "1" or "ALL" of DVD video discs can be used on this unit.



DVD Video Disc

DVD video discs are divided into titles, and the titles are subdivided into chapters.

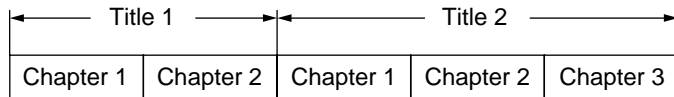

There are the marks on some DVD video disc package.

Examples:



Multiple languages



Multi-language subtitles



Multi-angle

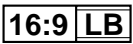

Multi-aspect



Region Number



Closed caption

Audio CD Disc

Audio CD discs are divided into tracks.

Track 1	Track 2	Track 3	Track 4	Track 5
---------	---------	---------	---------	---------

CAUTION:

- Only the above types of discs can be played on this unit. DVD-ROM, CD-ROM, SVCD, CVD, VCD, etc. cannot be played.
- This unit can play back the DVD-R that has recorded movie data as well. However, some DVD-Rs cannot be played back depending on the recording conditions.
- The DVD-R that has no movie data cannot be played back.
- This unit is to be used exclusively with the NTSC color system. PAL and SECAM system discs cannot be used with this unit.
- **For MP3/WMA CD, please see page E23.**
- **For Picture/JPEG CD, please see pages E25 and E26.**

Handling, Storing and Cleaning Discs

- Fingerprints and dust should be carefully wiped from the signal surface of the disc (glossy side) with a soft cloth. Wipe in a straight motion from the center to the outside of the disc.
- Never use chemicals such as record cleaning sprays, antistatic sprays or fluids, benzene or thinner to clean the discs. These chemicals will permanently damage the plastic surface of the disc.
- To remove a disc from its storage case, press down on the center of the case and lift the disc out, holding it carefully by the edges.
- Discs should be returned to their cases after use to protect them from dust and scratches.
- To prevent warping the disc, do not expose it to direct sunlight, high humidity or high temperatures for extended periods of time.
- Do not apply paper or write anything on either side of the disc. Sharp writing instruments, or the inks used in some felt-tip pens, may damage the surfaces of the disc.

This product incorporates copyright protection technology that is protected by method claims of certain U.S. patents and other intellectual property rights owned by Macrovision Corporation and other rights owners. Use of this copyright protection technology must be authorized by Macrovision Corporation, and is intended for home and other limited viewing uses only unless otherwise authorized by Macrovision Corporation. Reverse engineering or disassembly is prohibited.

BASIC OPERATION

Preparations

- Turn on the power (TV, Audio System, AV amplifier, etc.).
- **Select the video input source from your television.**
(Please refer to your TV instruction manual.)

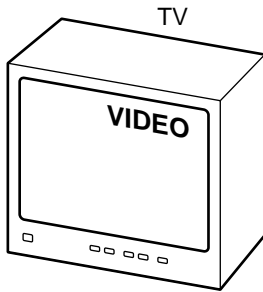

- Select the playback picture size according to the aspect ratio of the TV. (For more details, see "Setting Display" on page E28.)

4:3 LB
(Letterbox):

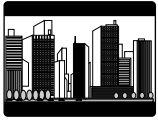

4:3 PS
(Panscan):

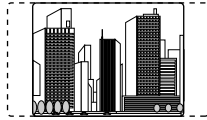

16:9 :

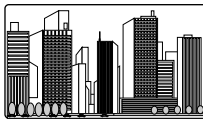

- Select the audio input source (Audio System, AV amplifier, etc.).
- **When the DVD video player is connected to the COMPONENT VIDEO OUT jacks of the TV (see pages E6, E8, and E9), you must select the INTERLACE or PROGRESSIVE position.**

Note: Initial setting is "INTERLACE".

1. Turn on the power (TV and DVD video player).
2. In "No Disc" mode, press and hold down [▶] on the DVD video player until "I" (INTERLACE) or "P" (PROGRESSIVE) appears on the TV screen.

Conventional TV: Select "I".

TV with Progressive-scan Capability: Select "P".

Note:

In "P" mode, the closed caption may not appear on the TV screen.

Important Note:

- This instruction manual explains the basic instruction of this unit using the remote control.
- Some DVD video discs have different functions that may not be explained in this instruction manual. You may need extra instructions. In this case, please follow the instructions displayed on the TV screen or jacket or case of the disc.
- "⊘" may appear on the TV screen during operation. This icon means that the function is not available on the disc now.
- For improvement, FL displays and on-screen displays subject to change without notice.

Basic Playback

Notes:

- Do not touch the disc tray while it is moving.
- Never place anything except a disc on the disc tray. Foreign objects can damage the unit.
- Do not apply excessive force to the disc tray.
- Discs must be placed on the disc tray one at a time.

When operation buttons are pressed, that operation is displayed on the TV screen. The display turns off after several seconds.

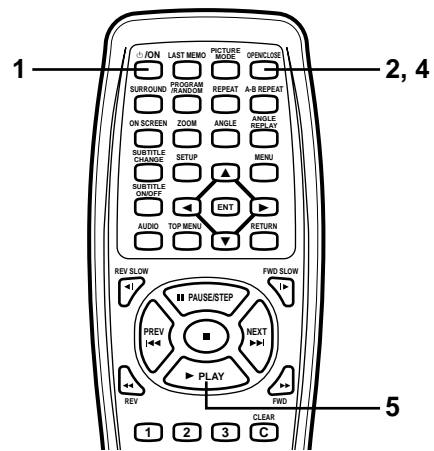
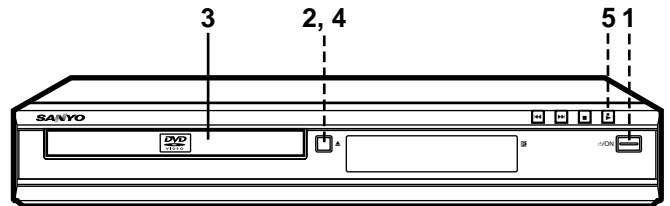

1. Press [ON].
 - "SANYO" logo appears on the TV screen.
 - "-----" blinks, and then "NO DISC" appears on the FL display.
2. Press [▲] (or [OPEN/CLOSE] on the remote control).
 - "OPEN" appears on the FL display and the disc tray opens.

Note:

To open or close the disc tray, be sure to press [▲] (or [OPEN/CLOSE] on the remote control). Do not press the disc tray with your hand.

3. Place the disc with the label facing up on the disc tray.

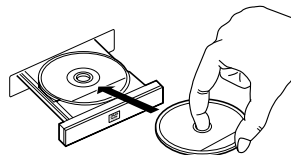

For 5-inch (12cm) disc

or

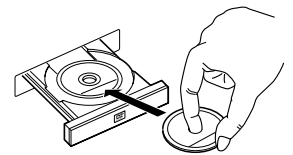

For 3-inch (8cm) disc

- Press [▲] (or [OPEN/CLOSE] on the remote control) again.
 - The disc tray closes.
 - “Reading” appears on the TV screen.
- Note:
Some discs may start playback automatically.
- Press [▶ PLAY] (or [▶] on the unit) to start playback.
 - “▶” appears.

Example:

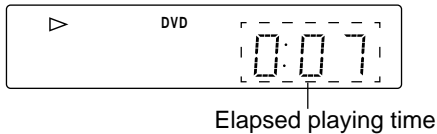

Notes:

- In some discs, even if 4:3 PS is selected, the black bands may remain on the screen.
- If the disc is loaded with the label side downward (and it is a single sided disc), or if a badly scratched disc is loaded, “No Play” appears on the TV screen. If this occurs, load the disc correctly or replace the disc.

If a DVD disc menu screen appears on the TV screen...

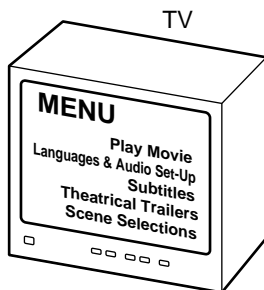

- Press [▲], [▶], [▼] or [◀] (or the number buttons) to select the desired menu.
- Press [ENT].
Playback of the selected menu starts.

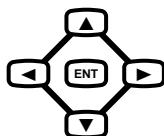

Note:

For more details, please refer to the jacket or case of the disc.

To lock the disc tray

You can lock the disc tray to prevent misuse of young children. While the disc tray is opened, press [▲] on the unit until “LOC” appears on the FL display (or “Disc Tray Locked” appears on the TV screen). (The disc tray closes.)

- The OPEN/CLOSE (or [▲]) button will not function.
- To release this mode, press [▲] on the unit until “UN-LOC” appears on the FL display (or “Disc Tray Unlocked” appears on the TV screen).

Stopping Playback

[DVD]

- Press [■] **once** during playback. “Resume ■” appears briefly on the TV screen.
When you press [▶ PLAY] (or [▶] on the unit), playback starts automatically from the point where you stopped. “▶” appears briefly on the TV screen.
- Note:
Some discs may not resume playback.
- Press [■] **twice** during playback. “■” appears briefly on the TV screen and playback stops completely.
When you press [▶ PLAY] (or [▶]), playback starts from the beginning of the disc.

[CD]

- Press [■] **once** during playback. The unit stops completely.

To turn off the power, press [⏻/ON]. “OFF” appears briefly on the FL display.

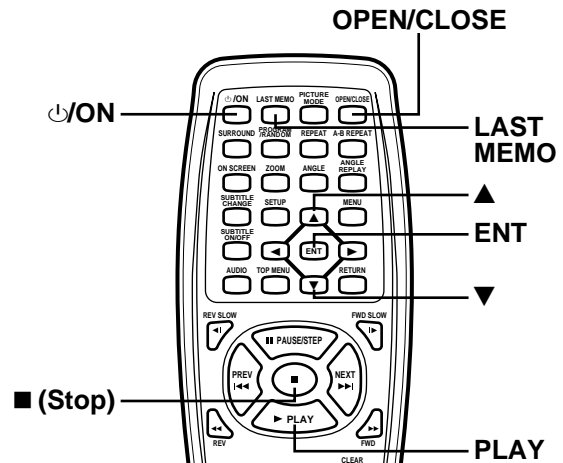

Continuing Playback from Where You Stopped Watching (LAST MEMO PLAY), for DVD only

- Press [LAST MEMO] to stop playback.
“Last Memo ■” appears briefly on the TV screen.
“LM” and “StOP” appear on the FL display.
- Press [OPEN/CLOSE] (or [▲] on the unit) to open the disc tray to change the disc, or press [⏻/ON] to turn off the power.
- Load the disc (or press [▶ PLAY]), or press [⏻/ON] again.
“Last Memo Play?” screen appears on the TV screen.
- Press [▲] to select “Yes”.

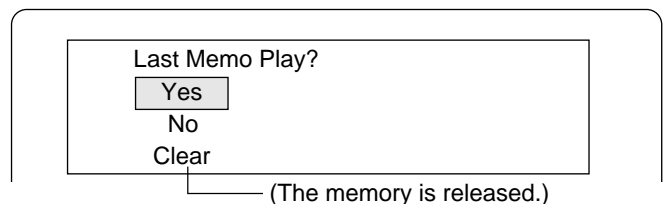

- Press [ENT].
Playback resumes from the point where you stopped.
If desired, press [LAST MEMO] again.

Notes:

- Point on up to 3 discs can be memorized.
- The Last Memo Play mode may not work correctly with some discs.

Selecting a DVD Menu

Notes:

- The operation may differ depending on the disc used.
- Selecting a menu may not be possible on some discs.

1. Press [MENU].
The main menu screen will appear.

Note:

Press [MENU] again to resume playback.

2. Press [▲], [▼], [◀] or [▶] (or the number buttons) to select the desired menu.
3. Press [ENT]
The selected menu playback starts.

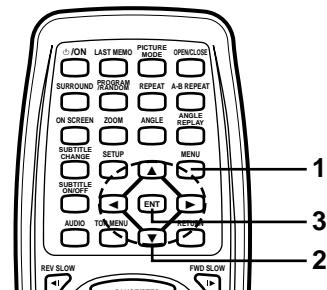

Selecting a Top Menu [DVD]

Notes:

- The operation may differ depending on the disc used.
- Selecting a top menu may not be possible on some discs.

1. Press [TOP MENU].
The top menu will appear (if the disc contains a top menu).
2. Press [▲], [▼], [◀] or [▶] (or the number buttons) to select the desired menu.
3. Press [ENT].
The selected menu playback starts.

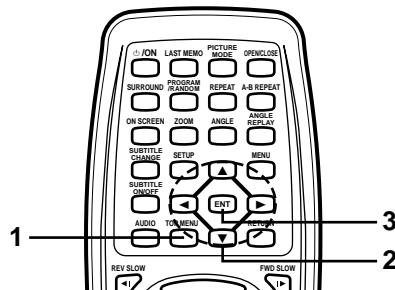

Chapter (Track) Skip

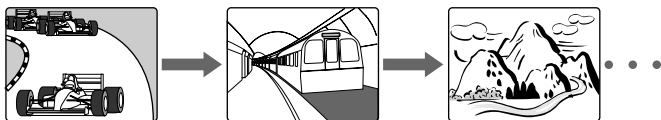

Skipping forward

Press [NEXT ►►] (or ►►) during playback to skip to the next chapter (or track).

“►►” appears briefly on the TV screen.

A chapter (or track) is skipped each time the button is pressed.

Skipping backward

Press [PREV ◀◀] (or ◀◀) during playback to skip back to the beginning of the chapter (or track) currently play.

“◀◀” appears briefly on the TV screen.

Press the button again immediately to skip back to the beginning of the previous chapter (or track).

Note:

You can skip only through the chapters, not over the title on the DVD disc.

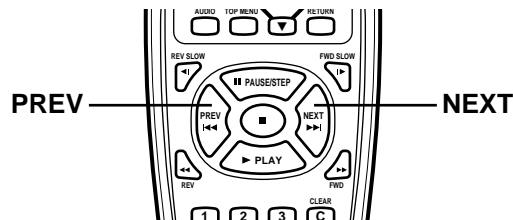
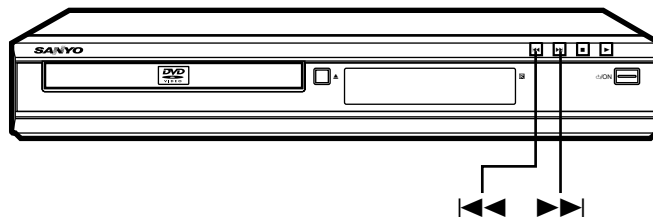

Important Note:

“⊙” may appear on the TV screen during operation. This icon means that the function is not available on the disc now.

Title Search [DVD]

1. Press [SEARCH MODE] **once** during playback or in the stop mode.

The title search screen appears on the TV screen.

Example:

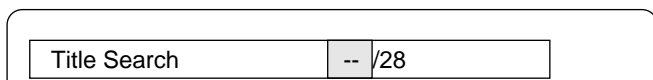

2. Press the number button(s) to enter the title number.

Example:

To select Title No.3, press [3].

To select Title No.10, press [1], then [0].

To select Title No.24, press [2], then [4].

Note:

If you make a mistake, press [CLEAR].

3. Press [▶ PLAY].

Playback starts from the selected title.

Chapter Search [DVD]

1. Press [SEARCH MODE] **twice** during playback.

The chapter search screen appears on the TV screen.

Example:

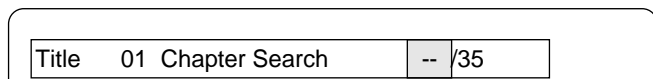

2. Press the number button(s) to enter the chapter number.

Example:

To select Chapter No.3, press [3].

To select Chapter No.10, press [1], then [0].

To select Chapter No.24, press [2], then [4].

Note:

If you make a mistake, press [CLEAR].

3. Press [▶ PLAY].

Playback starts from the selected chapter .

Time Search [DVD]

1. Press [SEARCH MODE] **three times** during playback.

The time search screen appears on the TV screen.

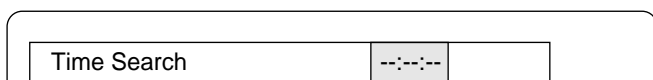

2. Press the number button(s) to enter the time.

Example:

20 minutes 5 seconds Press [2], [0], [0] and [5].

42 minutes 39 seconds Press [4], [2], [3] and [9].

1 hour 4 minutes 35 seconds Press [1], [0], [4], [3] and [5].

Note:

If you make a mistake, press [CLEAR].

3. Press [▶ PLAY].

Playback starts from the searched time.

Note:

The Search mode may not work on some discs.

Important Note:

“⊘” may appear on the TV screen during operation. This icon means that the function is not available on the disc now.

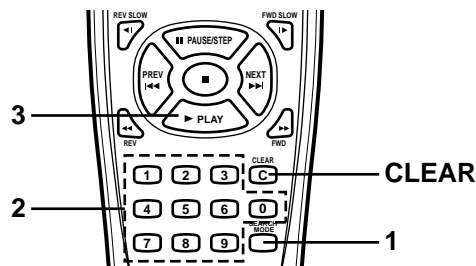

Time Search [CD]

1. Press [SEARCH MODE] **once** during playback.

The time search screen appears on the TV screen.

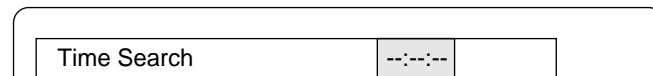

2. Press the number button(s) to enter the time.

Example:

2 minutes 5 seconds Press [2], [0] and [5].

42 minutes 39 seconds Press [4], [2], [3] and [9].

Note:

If you make a mistake, press [CLEAR].

3. Press [▶ PLAY].

Playback starts from the searched time in the track.

Track Search [CD]

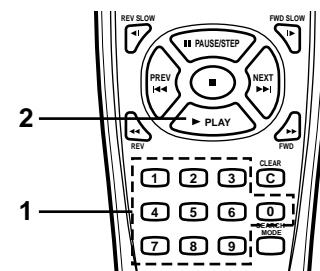

1. Press the number buttons during playback or in the stop mode.

Example:

To select Track No. 3, press [3].

To select Track No. 10, press [1], then [0].

To select Track No. 24, press [2], then [4].

Note:

If you make a mistake, press [CLEAR].

2. Press [▶ PLAY].

Playback starts from the selected track.

Fast Playback

Fast forward playback

Press [FWD ►►] repeatedly to select the fast speed forward playback (up to 200 times normal speed in DVD).

[DVD]

►► 1 → ►► 2 → ►► 3 → ►► 4 (4 steps)

[CD]

►► 1 → ►► 2 (2 steps)

Press [► PLAY] to return to normal playback.

Fast reverse playback

Press [REV ◀◀] repeatedly to select the fast speed reverse playback (up to 200 times normal speed in DVD).

[DVD]

◀◀ 1 → ◀◀ 2 → ◀◀ 3 → ◀◀ 4 (4 steps)

[CD]

◀◀ 1 → ◀◀ 2 (2 steps)

Press [► PLAY] to return to normal playback.

Note:

The sound is muted during fast playback in DVD.

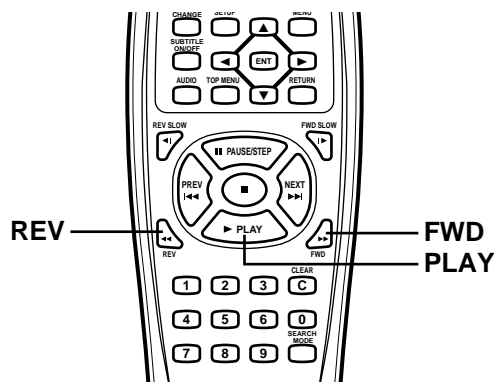

Important Note:

“⊘” may appear on the TV screen during operation. This icon means that the function is not available on the disc now.

Slow Motion Playback [DVD]

Forward slow playback

Press [FWD SLOW ►|] repeatedly to select the forward slow speed playback.

►| 1 → ►| 2 → ►| 3 → ►| 4 (4 steps)

Press [► PLAY] to return to normal playback.

Reverse slow playback

Press [REV SLOW ◀|] repeatedly to select the reverse slow speed playback.

◀| 1 → ◀| 2 → ◀| 3 → ◀| 4 (4 steps)

Press [► PLAY] to return to normal playback.

Note:

The sound is muted during slow motion playback.

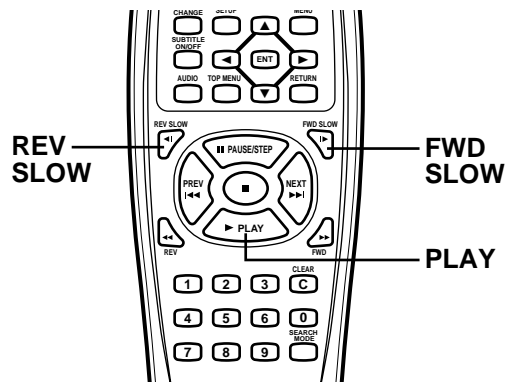

Still Picture (Pause)

Press [|| PAUSE/STEP] during playback.

- “||” appears on the FL display.
- “||” appears briefly on the TV screen.

[DVD]

Still picture mode

[CD]

Pause mode

Press [► PLAY] to return to normal playback.

Note:

The sound is muted during still picture.

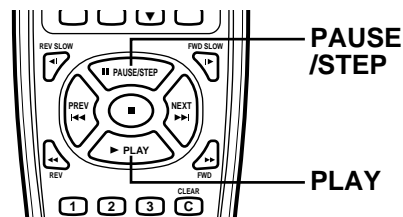

Frame by Frame Advance Playback [DVD]

Press [|| PAUSE/STEP] during still picture.

- “||►” appears briefly on the TV screen.
- Each time the button is pressed, the picture advances one frame. Press [► PLAY] to return to normal playback.

Notes:

- The sound is muted.
- Frame playback is operated forward only.

Picture Zoom (Pin Point Zoom) [DVD]

1. Press [ZOOM] during normal/slow playback or still picture.
The pin point guide appears on the TV screen.

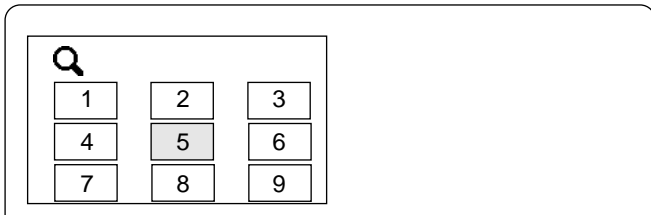

The guide divides the screen into nine, and the number shows the point.

Note:

If you quit the screen, press [ZOOM].

2. To select the point, do one of the following:
 - Press [▲], [▶], [▼] or [◀], and press [ENT].
 - Press the number button.



- The screen is magnified.
- “Q 1” appears briefly on the TV screen.
- If necessary, press [▲], [▶], [▼] or [◀] repeatedly to move the screen as desired.

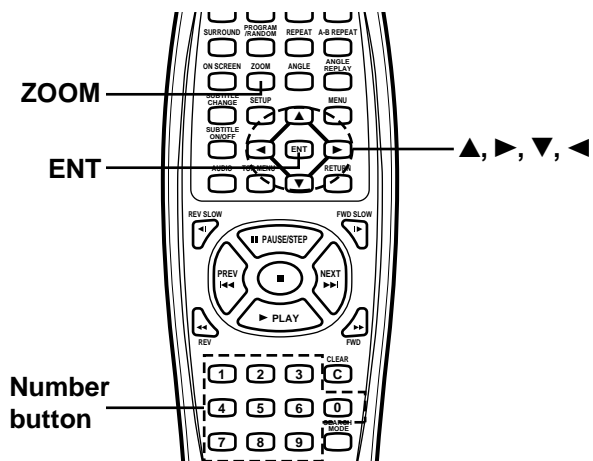

3. Press [ZOOM] again.
 - The screen is magnified more than “Q 1”.
 - “Q 2” appears briefly on the TV screen.
 - If necessary, press [▲], [▶], [▼] or [◀] repeatedly to move the screen as desired.
4. Press [ZOOM] to return to the original screen.
 - “Q Off” appears briefly on the TV screen.

Note:

Pin Point Zoom may not work on some discs.

Viewing from a Desired Camera Angle (Multi-Angle) [DVD]

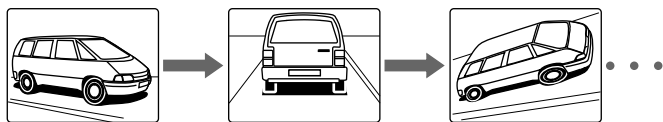

Some DVD video discs may contain scenes which have been shot simultaneously from a number of different camera angles. The jacket or case of discs that are recorded with angles will be marked.

Example:



Note:

The recorded angles differ depending on the disc used.

1. Play the disc that is recorded with angles.
2. Press [ANGLE] repeatedly until the desired angle appears.

Example:



Angle Replay

During Multi-angle playback screen, press [ANGLE REPLAY]. The unit skips back to last approximately 10 seconds, changes it to the next camera angle and plays it, and continues playback. If desired, press the button again.

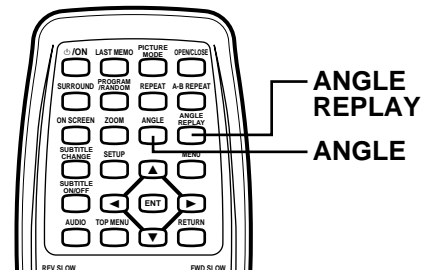

Important Note:

“⊘” may appear on the TV screen during operation. This icon means that the function is not available on the disc now.

Repeat Playback

Press [REPEAT] during playback (or programmed playback) of the title (or track) you want to repeat.

Each time the button is pressed, the repeat mode will be changed as follows.

[DVD]

TV screen	FL display	Operation
↻ Chapter	REP 1	Repeat of chapter being played
↻ Title	ALL REP	Repeat of title being played
↻ Off		Normal playback mode

[CD]

During Normal Playback

TV screen	FL display	Operation
↻ 1	REP 1	Repeat of track being played
↻ All	ALL REP	Repeat all tracks
↻ Off		Normal playback mode

During Programmed Playback

TV screen	FL display	Operation
↻ Program 1	REP 1	Repeat the programmed track being played
↻ Program All	ALL REP	Repeat all programmed tracks
↻ Off		Original programmed playback mode

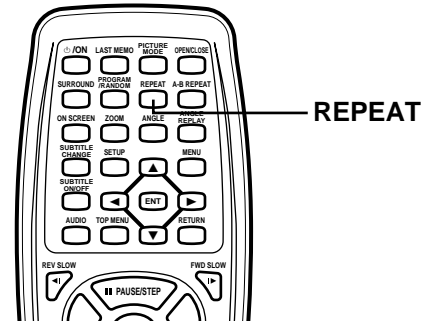

During Random Playback

TV screen	FL display	Operation
↻ 1	REP 1	Repeat of track being played
↻ All	ALL REP	Repeat all tracks at random
↻ Off		Original random playback mode

Designated Range Repeat Playback (A-B Repeat)

- Press [A-B REPEAT] during playback at the beginning of the section you want to repeat (Point A).
 - "A-" appears on the TV screen.
 - "A-" appears on the FL display.
- Press [A-B REPEAT] again at the end of the section you want to repeat (Point B).
 - "B" appears briefly on the TV screen.
 - "B" appears, and "A-B" remains lit on the FL display.

The section between points A and B is played repeatedly.
- To return to normal playback, press [A-B REPEAT] again.
 - "Off" appears briefly on the TV screen.

Note:

Repeat playback or A-B repeat playback mode may not work correctly with some discs.

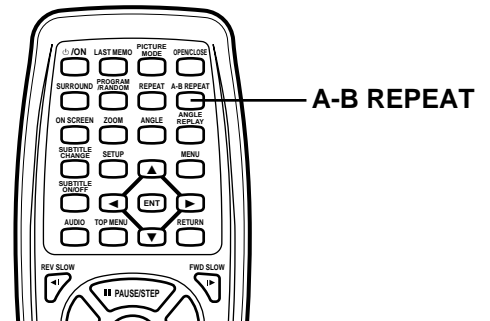

Important Note:

"⊘" may appear on the TV screen during operation. This icon means that the function is not available on the disc now.

Random Playback [CD]

1. Press [PROGRAM/RANDOM] **once** in the stop mode.
 - “Random” appears on the TV screen.
2. Press [▶ PLAY] to begin random playback.
 - “RND” appears on the FL display.
 - The unit will automatically select tracks at random.

Notes:

- To stop random playback, press [■].
- [A-B REPEAT] and [SEARCH MODE] do not work during Random Playback.

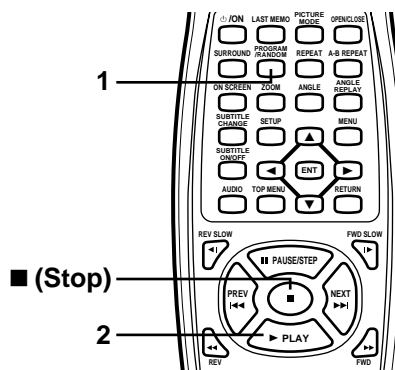

Important Note:

“⊘” may appear on the TV screen during operation. This icon means that the function is not available on the disc now.

Programmed Playback [CD]

Up to 20 selections can be programmed.

Programming procedure

1. Press [PROGRAM/RANDOM] **twice** in the stop mode.
 - “Program Mode” screen appears.
2. Press the number buttons to select the track number.

Example:

To select Track No.3, press [0], then [3].
 To select Track No.10, press [1], then [0].
 To select Track No.24, press [2], then [4].

Notes:

- If you make a mistake, press [CLEAR].
- To quit the “Program Mode” screen, press [PROGRAM/RANDOM].

3. Press [▼] to move the highlighted box down.

Example:

Program Mode				
All Clear				
1	03	6 --	11 --	16 --
2	--	7 --	12 --	17 --
3	--	8 --	13 --	18 --
4	--	9 --	14 --	19 --
5	--	10 --	15 --	20 --

4. Repeat steps 2 and 3 as above to select another track.
5. Press [▶ PLAY] to start playback.
 - “PGM” appears on the FL display.
 - When all programmed selections have played, the unit stops automatically.
 - The program contents are retained in memory.

Note:

To play the program again, press [PROGRAM/RANDOM] **twice** to call up the “Program Mode” screen, then press [▶ PLAY].

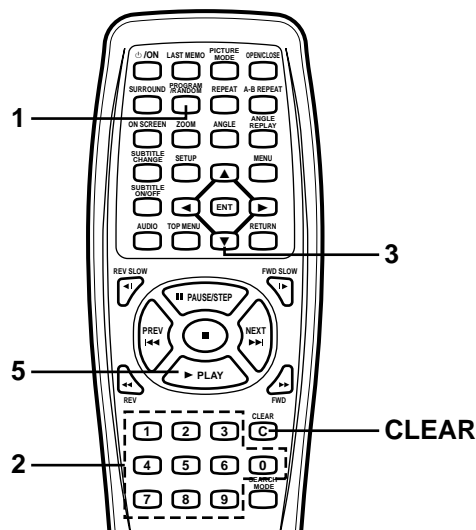

To clear the program one by one

1. Press [PROGRAM/RANDOM] **twice** to display the “Program Mode” screen.
2. Press [▲] or [▼] to select the track number.
3. Press [CLEAR].

To clear all the programs

1. Press [PROGRAM/RANDOM] **twice** to display the “Program Mode” screen.
2. Press [▲] to select “All Clear”.
3. Press [ENT].

To change the program



1. Press [PROGRAM/RANDOM] **twice** to display the “Program Mode” screen.
2. Press [▲] or [▼] to select the track number.
3. Press the number buttons to select the track number to be replaced.

Note:

To quit the “Program Mode” screen, press [PROGRAM/RANDOM].

Selecting Subtitle Language [DVD]

This operation works only with discs on which multiple subtitle languages are recorded.

1. Press [SUBTITLE ON/OFF] during playback.
The subtitle language mark appears. (Example:  1/3 en)
If “  Off” appears, press the button again.
2. Press [SUBTITLE CHANGE] repeatedly until the desired subtitle language appears on the TV screen.
After a few seconds, “  ” disappears.
Example:



Notes:

- In some cases, the subtitle language is not changed to the selected one.
- When a disc supporting closed caption is played, the subtitle and the closed caption may overlap each other on the TV screen. In this case, turn the subtitle off.
- When the desired language is not selected even if the button is pressed, the language is not available on the disc.
- When the power is turned on or the disc is replaced, select the subtitle language again.
- If the subtitle language is not necessary, press [SUBTITLE ON/OFF] to select “  Off”.
- Please refer to “Setting Language” on page E27.

Selecting Audio Soundtrack Language (Multi-Language) [DVD]

This operation works only with discs on which multiple audio soundtrack languages are recorded.

1. Press [AUDIO] during playback.
2. Press [AUDIO] repeatedly until the desired language appears on the TV screen.
Examples:

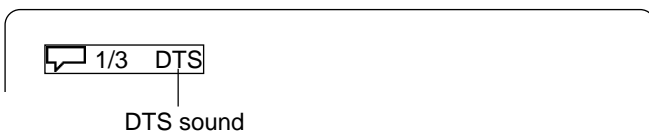

(If using an amplifier with DTS Decoder, the DTS sound will be heard. See page E10 for the amplifier connection.)

Notes:

- When the desired language is not selected even if the button is pressed, the language is not available on the disc.
- When the power is turned on or the disc is replaced, select the language again.
- If the language is not recorded on the disc, only the available language on the disc will be heard.

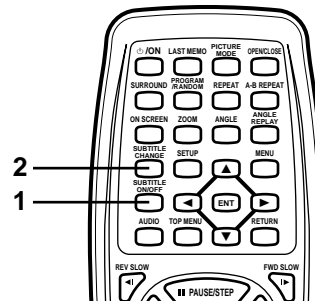

Important Note:

“  ” may appear on the TV screen during operation. This icon means that the function is not available on the disc now.

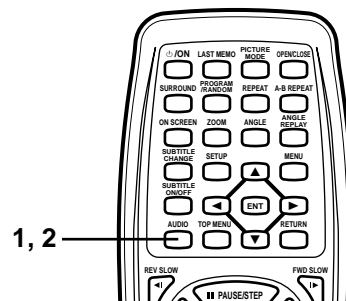
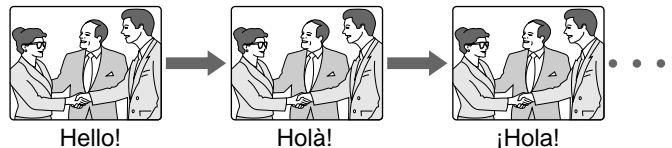

Selecting On-Screen Information

Press [ON SCREEN] repeatedly to show the disc information (Title, Chapter, Title elapsed playing time, Language, etc.).

Example for DVD:

1. Press [ON SCREEN] during playback.

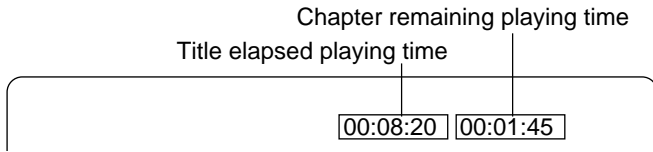

2. Press [ON SCREEN] again.

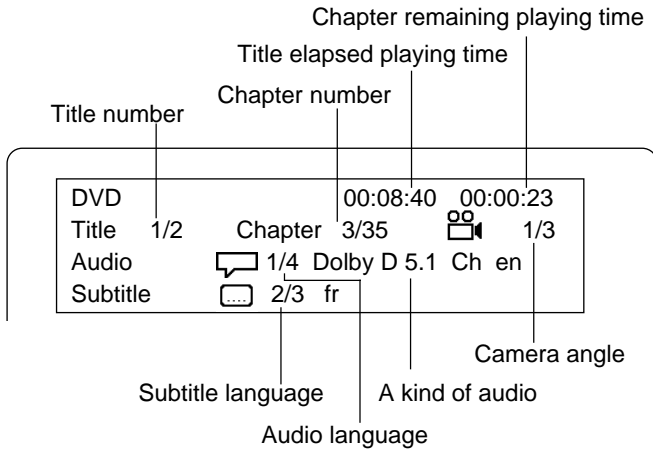

3. Press [ON SCREEN] to close the disc information.

For improvement, on-screen displays subject to change without notice.

Example for Audio CD:

1. Press [ON SCREEN].

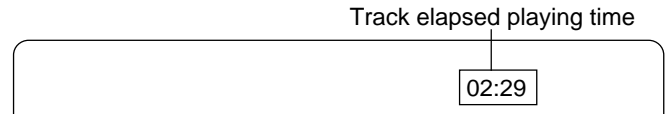

2. Press [ON SCREEN] again.

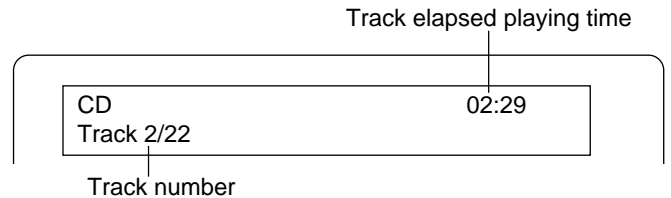

3. Press [ON SCREEN] to close the disc information.

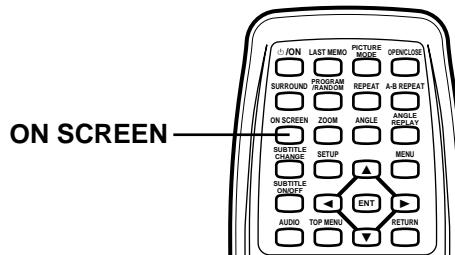

Selecting Picture Mode

Press [PICTURE MODE] to show the picture mode. Each time the button is pressed, the picture mode changes as follows:

Standard ⇌ Mild ⇌ Black and White ⇌ Standard ...

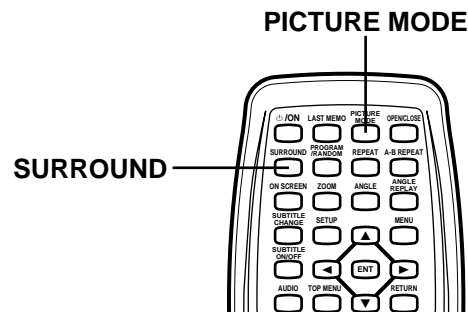

Selecting Spatializer N-2-2™ Virtual Surround Sound Mode [DVD] [CD]

Press [SURROUND] to set the Spatializer N-2-2 Virtual Surround Sound.

“ On” appears briefly on the TV screen.

“3D” appears on the FL display.

Press the button again to return to the original mode.

“ Off” appears briefly on the TV screen.

“3D” disappears.

Portions of this product are licensed from Desper Products, Inc., a subsidiary of Spatializer Audio Laboratories, Inc. Copyright ©1997-2002 Spatializer Audio Laboratories, Inc. All Rights Reserved Worldwide. *Spatializer*®, N-2-2™ and the circle-in-square device are trademarks of Desper Products, Inc.

Important Note:

“” may appear on the TV screen during operation. This icon means that the function is not available on the disc now.

MP3/WMA CD OPERATION

Before Starting

This unit can play back the CD that has recorded music data, MP3 or WMA (Windows Media Audio) files.

- The file system is ISO9660 Level 1 and Level 2.
- If the CD has both audio CD tracks and MP3/WMA files, only audio CD tracks are played.
- It would take 30 seconds or more for this unit to read MP3/WMA files depending on its structure.
- This unit can recognize up to 256 files or folders per disc. The CD with 257 files or folders and over is not available to this unit.
- MP3/WMA CDs may not be played in the recorded order.
 1. Please use the MP3 or WMA software with the function that can record data alphabetically or numerically.
 2. Please refrain from making many sub-folders by preference.

However, some CD-R/RWs cannot be played back depending on the recording conditions. Before playing back MP3 or WMA files, please read the following.

MP3 CD

- MP3 files must have the extension letters, “.MP3” or “.mp3”.
- Standard, sampling frequency, and the bit rate:
MPEG-1 Audio
32kHz, 44.1kHz, 48kHz
32kbps ~ 320kbps (constant bit rate or variable bit rate)
- The recommend recording setting for a high-quality sound is 44.1kHz of sampling frequency and 128kbps of constant bit rate.

WMA CD

- When creating a WMA disc, be sure the copyright function is off.
- WMA files must have the extension letters, “.WMA” or “.wma”.
- Standard, sampling frequency, and the bit rate:
WMA version 7, and 8
32kHz, 48kbps ~ 64kbps
44.1kHz, 48kbps ~ 192kbps
48kHz, 128kbps ~ 192kbps
- DRM files cannot be played back.

Microsoft, Windows Media, and Windows Logo are trademarks or registered trademarks of Microsoft Corporation in both the United States and other countries.

LIMITATIONS ON DISPLAY

- Available letters for display are the following: capital or small alphabets of A through Z, and numbers of 0 through 9.
- Other letters than those above are replaced in “-” (hyphen).

CAUTION:

- Some MP3/WMA CDs cannot be played back depending on the recording conditions.
- The CD has no music data or non-MP3/WMA files cannot be played back.

MP3/WMA CD Playback

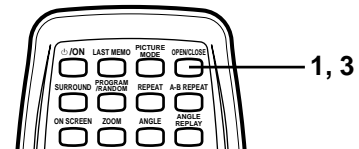
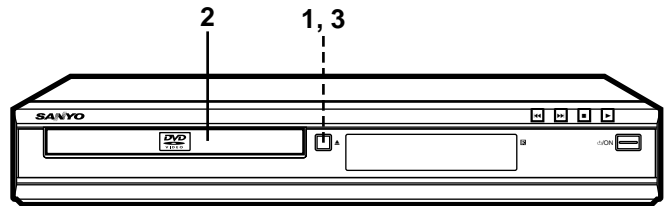

1. Press [▲] (or [OPEN/CLOSE] on the remote control).
 - “OPEN” appears on the FL display, and the disc tray opens.

Note:

To open or close the disc tray, be sure to press [▲] (or [OPEN/CLOSE] on the remote control). Do not press the disc tray with your hand.

2. Place the disc with the label facing up on the disc tray.

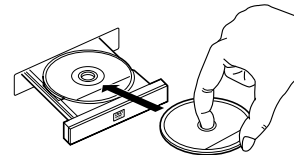

3. Press [▲] (or [OPEN/CLOSE] on the remote control).
 - The disc tray closes.
 - “FILE” appears on the FL display.
 - A table of contents in the first directory appears on the TV screen.

Example:

File	-/24	00:00:00
HYPER-EURO-MAX		
1	MUSIC001	8
2	MUSIC002	9
3	MUSIC003	10
4	MUSIC004	11
5	MUSIC005	12
6	MUSIC006	
7	MUSIC007	
File: MAX		

File information

Note:

If the disc is loaded with the label side downward, or if a badly scratched disc is loaded, “No Play” appears on the TV screen. If this occurs, load the disc correctly or replace the disc.

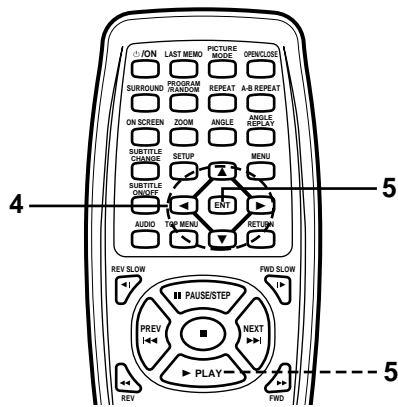

4. Press [▲], [▶], [▼] or [◀] to move the highlighted box to the desired file.
 - To go on to the next or previous directory, press [▲], [▶], [▼] or [◀].
 - To go back to the previous directory, press [RETURN].
 - In some discs, if [MENU] is pressed, it goes back to the first directory.
5. Press [ENT] (or ▶ PLAY) to start playback.
 - “▶” appears briefly on the TV screen.
 - The letter’s color in the highlighted box turns green.
 - “MP3” or “WMA” appears on the FL display.

Example: (the second directory)

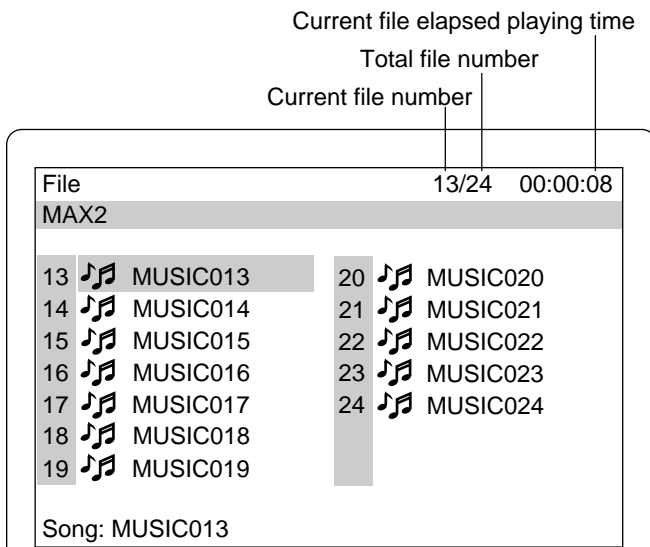

Important Note:

“⊘” may appear on the TV screen during operation. This icon means that the function is not available on the disc now.

Stopping Playback

Press [■] during playback. “■” appears briefly on the TV screen and playback stops completely.

Pause

Press [|| PAUSE/STEP] during playback.

- “||” appears briefly on the TV screen.
- “||” appears on the FL display.

Note:

The sound is muted.

Press [▶ PLAY] to return to normal playback.

File Skip

Skipping forward

Press [NEXT ▶▶] during playback to skip to the next file.

“▶▶” appears briefly on the TV screen.

Skipping backward

Press [PREV ◀◀] during playback to skip back to the beginning of the file currently play.

“◀◀” appears briefly on the TV screen.

Press the button again immediately to skip back to the beginning of the previous file.

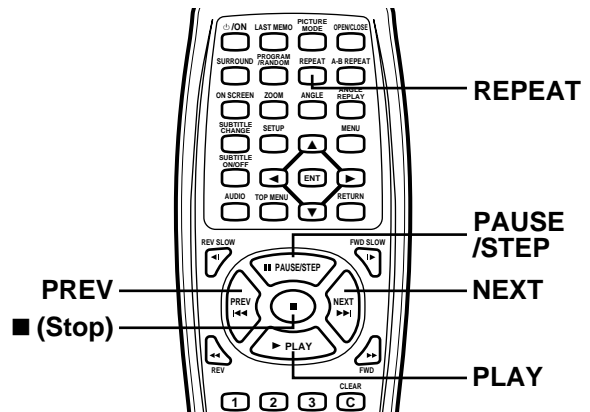

Repeat Playback

Press [REPEAT] during playback.

Each time the button is pressed, the repeat mode will be changed as follows.

TV screen	FL display	Operation
↻ 1	REP 1	Repeat of file being played
↻ All	ALL REP	Repeat all files
↻ Off		Normal playback mode

Note:

Repeat playback may not work correctly with some discs.

PICTURE DISC OPERATION

KODAK Picture CD Playback

With KODAK Picture CD, it's easy to turn film into pictures you can email from your PC and view on this DVD video player! Just bring your film in for processing, and check the box for KODAK Picture CD. You'll get back your prints and negatives as usual - plus you'll get a special CD that contains your pictures along with software that lets you view, enhance, share, and print your pictures from your computer and view them on this DVD video player.

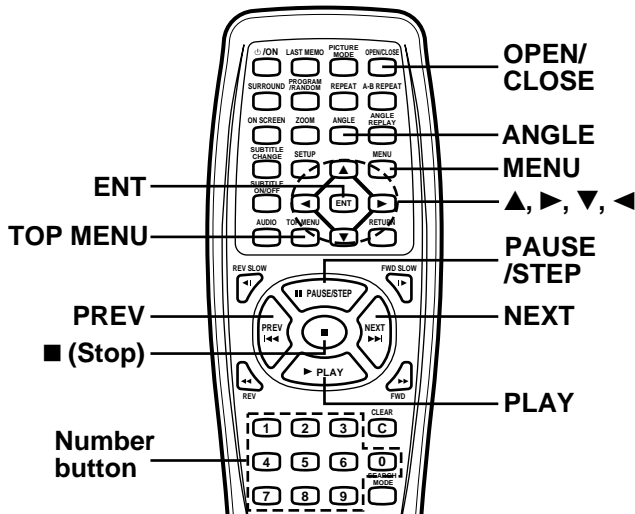

1. Load the disc with the label facing up on the disc tray. (Please refer to "MP3/WMA CD OPERATION" on page E23.)
 - "PHOtO" appears on the FL display.
 - "Picture CD" appears briefly on the TV screen.
 - The first thumbnail pictures (maximum 9-picture) appear on the TV screen.

Example:

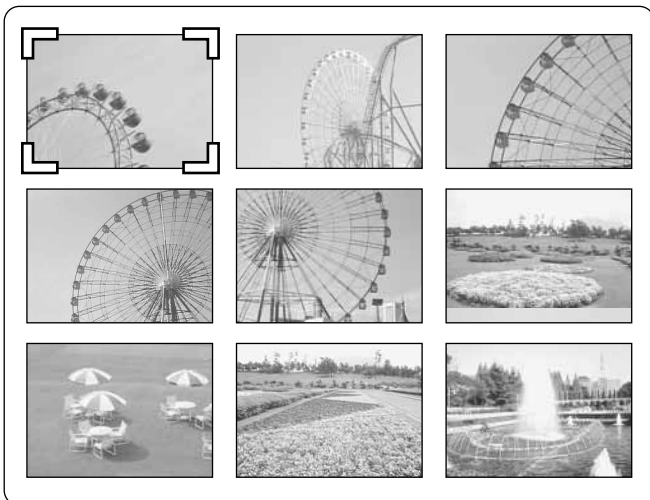

2. Press [▲], [▶], [▼] or [◀] to move the cursor to the desired picture.
 - To go to the next or previous thumbnail pictures, press [NEXT ▶▶] or [PREV ◀◀].
3. Press [ENT] (or [▶ PLAY]) to start the slide show from the selected picture.
 - If you press [|| PAUSE/STEP] during the slide show, the slide show stops temporary. "||" appears briefly. Press [▶ PLAY] (or [NEXT ▶▶]) again to resume the slide show.
 - **If the picture appears upside down or sideways, do the following steps.**
 - 1) Press [|| PAUSE/STEP], if necessary.
 - 2) Press [ANGLE] repeatedly until it's right side up. "↺90°", "↻180°", "↻270°" or "Normal" appears briefly on the TV screen.
 - 3) Press [▶ PLAY] (or [|| PAUSE/STEP]) to skip to the next picture and continue the slide show.
 - If you press [NEXT ▶▶] or [PREV ◀◀] during the slide show, it skips to the next picture or previous picture.



After the last picture has displayed, the last thumbnail pictures appear.

- To stop the slide show, press [■]. The thumbnail pictures appear.
- If [TOP MENU] is pressed during the slide show, the thumbnail pictures appear.

Notes:

- If you press [MENU], the file list appears.

Example:

Picture CD		-/37	00:00:00
PICTURES			
1	001-1A	8	008-8A
2	002-2A	9	009-9A
3	003-3A	10	010-10A
4	004-4A	11	011-11A
5	005-5A	12	012-12A
6	006-6A	13	013-13A
7	007-7A	14	014-14A
File: 001-1A			

- If you start the slide show from the file list..
 - 1) Press [▲], [▶], [▼] or [◀] to move the highlighted box to the desired file.
 - 2) Press [ENT] (or [▶ PLAY]) to start the slide show. The file list appears after the last picture has displayed.
- If you press [TOP MENU], the thumbnail pictures appear.
- FUJICOLOR CD can be used.
- Some discs cannot be played back depending on the recording conditions.

KODAK and Picture CD are registered trademarks of Eastman Kodak Company.

JPEG CD Playback















You can also view digital images from JPEG files on disc created by your computer.

- It would take 30 seconds or more for this unit to read the JPEG files depending on its structure.
- Some JPEG files cannot be played back depending on the recording conditions.

1. Load the disc with the label facing up on the disc tray. (Please refer to “MP3/WMA CD OPERATION” on page E23.)

- “FILE” appears on the FL display.
- The file list appears on the TV screen.

Example:

File		1/43		00:00:00	
Root					
1		001	8		008
2		002	9		009
3		003	10		010
4		004	11		011
5		005	12		012
6		006	13		013
7		007	14		014
File: 001					

2. Press [▲], [▶], [▼] or [◀] to move the highlighted box to the desired file.

3. Press [ENT] (or [▶ PLAY]) to start the slide show from the selected file.

- “PHOtO” appears on the FL display.
- If you press [|| PAUSE/STEP] during the slide show, the slide show stops temporary. “||” appears briefly. Press [▶ PLAY] (or [NEXT ▶▶]) again to resume the slide show.
- **If the picture appears upside down or sideways, do the following steps.**
 - 1) Press [|| PAUSE/STEP], if necessary.
 - 2) Press [ANGLE] repeatedly until it’s right side up. “↺90°”, “↻180°”, “↻270°” or “Normal” appears briefly on the TV screen.
 - 3) Press [▶ PLAY] (or [|| PAUSE/STEP]) to skip to the next picture and continue the slide show.
- If you press [NEXT ▶▶] or [PREV ◀◀] during the slide show, it skips to the next file or previous file.



After the last file has displayed, the file list appears.

Notes:

- To stop the slide show, press [■]. The file list appears.
- If the disc is loaded with the label side downward, or if a badly scratched disc is loaded, “No Play” appears on the TV screen. If this occurs, load the disc correctly or replace the disc.

Picture Zoom

1. Press [|| PAUSE/STEP] at the desired picture (KODAK Picture CD and JPEG CD).

2. Press [ZOOM].

3. Press [▲], [▶], [▼], [◀] and [ENT] (or number buttons). The picture is magnified.

(For more details, please refer to “Picture Zoom” on page E18.)

4. Press [▶ PLAY] to resume the slide show.

If the disc is mixed with MP3, WMA and JPEG files...

1. Press [▲], [▶], [▼] or [◀] to move the highlighted box to the desired file.

2. Press [ENT] (or [▶ PLAY]) to start playback (or slide show).

- If you start from the MP3 or WMA file, the unit plays both MP3 and WMA files. But the unit skips the JPEG files automatically.
- If you start from the JPEG file, the unit plays the JPEG files. But the unit skips both MP3 and WMA files automatically.

Important Note:

“⊘” may appear on the TV screen during operation. This icon means that the function is not available on the disc now.

INITIAL SETTINGS

Once the initial settings have been completed, the unit can always be operated under the same conditions. The settings will be retained in the memory until they are changed, even if the power is turned off.

Setting Language

1. Press [SETUP] in the stop mode.
The setup screen appears.
"Language" is highlighted.

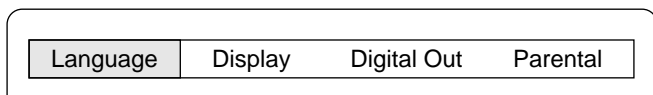

2. Press [ENT].
"Language" screen appears.
3. Press [▼] or [▲] to select the item (highlighted).
Example:

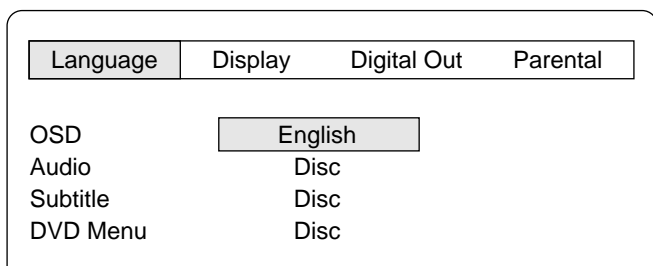

4. Press [ENT].
The submenu appears.
Example:

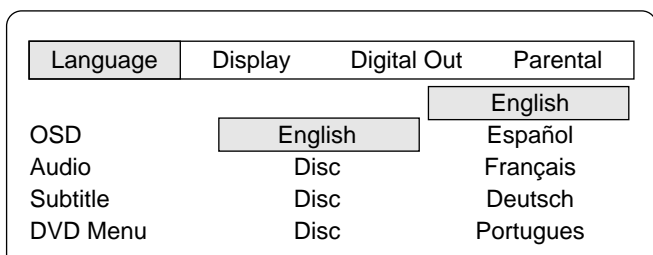

5. Press [▼] or [▲] to select the language (highlighted).
6. Press [ENT].
The selected language remains.
7. Repeat steps 3 ~ 6 for other items.
Note:
If "Others" is selected, enter the language code. (See "LANGUAGE CODE LIST" on page E31.)
8. Press [▲] to skip back to the setup screen (or press [SETUP]).

Notes:

- In this instruction manual, the language in on-screen display is English.
If you change the language, please follow the selected language in on-screen display.
- You cannot switch audio sound track languages if there is only one language recorded on the disc.
- When you play back a DVD video disc, the unit automatically displays the pre-selected subtitle language if it is included on the disc.
- If "Others" is selected, enter the language code. (See "LANGUAGE CODE LIST" on page E31.)
- For improvement, on-screen displays subject to change without notice.

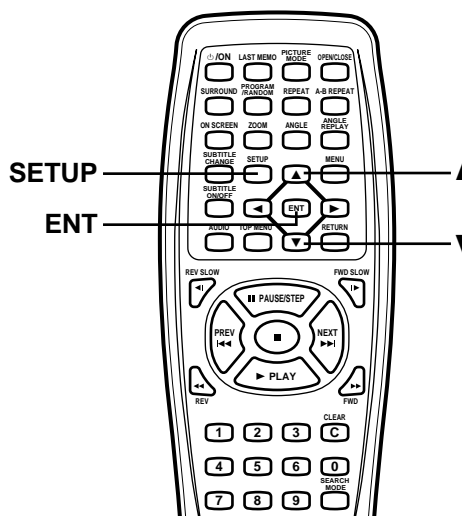

Setting Display

- Press [SETUP] in the stop mode.
The setup screen appears.

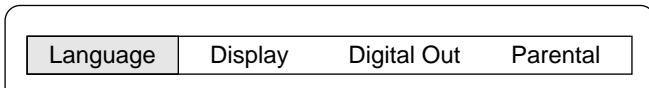

- Press [▶] to select "Display".
- Press [ENT].
"Display" screen appears.

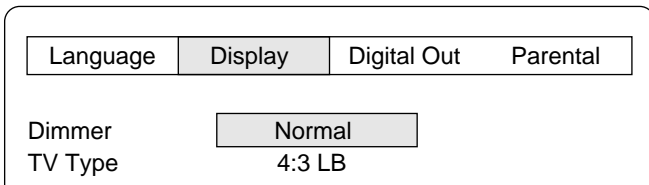

- Press [ENT] again.
The submenu (FL display brightness on the player, "Normal" and "Dark") appears.

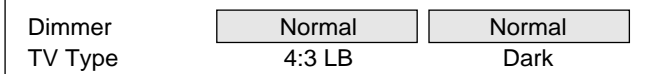

- Press [▼] or [▲] to select the FL display brightness.
Example: To select "Dark"

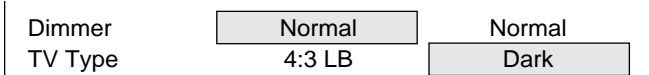

- Press [ENT].
(In this example, "Dimmer Dark" remains.)

- Press [▼] to select "TV Type".

- Press [ENT].
The submenu ("4:3 LB", "4:3 PS" and "16:9") appears.

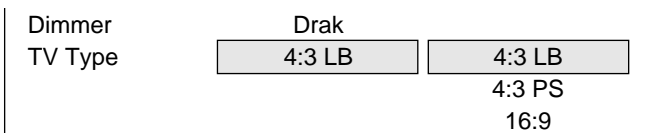

- Press [▼] or [▲] to select the appropriate setting for your TV screen size.
Example: To select "4:3 PS"

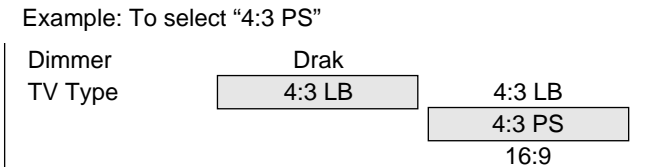

- Press [ENT].
(In this example, "TV Type 4:3 PS" remains.)
- Press [▲] to skip back to the setup screen (or press [SETUP]).

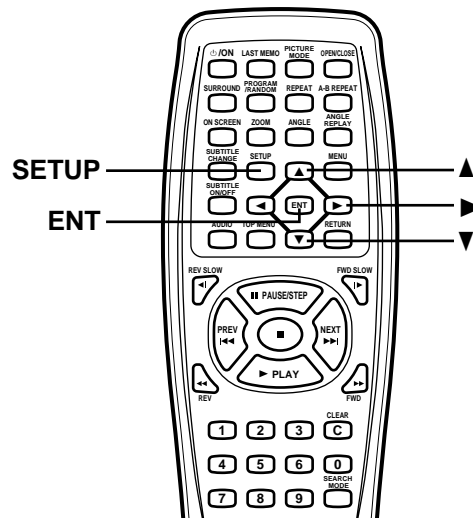

4:3 LB (Letterbox):

Select when a conventional TV set is connected.
When the wide screen disc is played back, the black bands appear at the top and bottom of screen.



4:3 PS (Panscan):

Select when a conventional TV set is connected.
When the wide screen disc is played back, it displays pictures cropped to fill to your TV screen. The left and right edges are cut off.

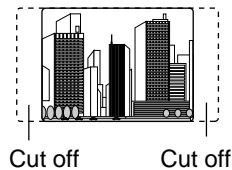

16:9 :

Select when a wide screen TV set is connected.
Played in "FULL" size. (Setting the wide screen TV to "FULL" mode is also necessary.)

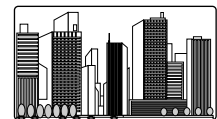

Notes:

- The screen size may differ depending on the DVD video discs.
- If you select 16:9 to get rid of the black bands on screen when wide screen disc is played back, picture may be slightly distorted.
- In some discs, even if 4:3 PS is selected, the black bands may remain on the screen.

Setting Digital Out

If the optical DIGITAL OUT jack is connected to the amplifier, you must set as follows:

1. Press [SETUP] in the stop mode.
The setup screen appears.

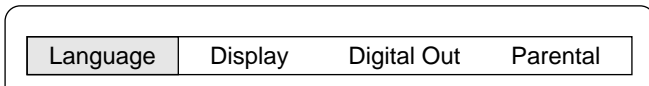

2. Press [▶] to select "Digital Out".
3. Press [ENT].
"Digital Out" screen appears.

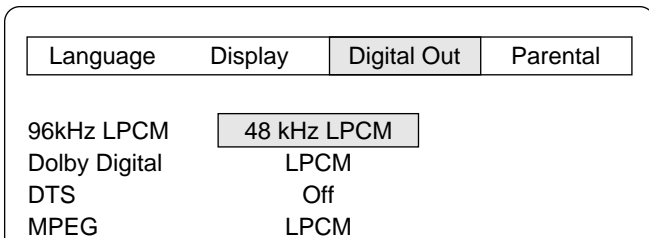

4. Press [▼] or [▲] to select the item (highlighted).
5. Press [ENT].
The submenu appears.
Example:

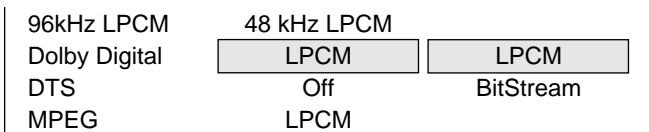

6. Press [▼] or [▲] to select the submenu (highlighted).
Example: To select "Dolby Digital BitStream"

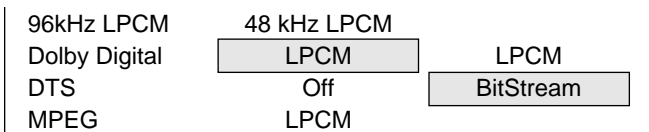

7. Press [ENT].
(In this example, "Dolby Digital BitStream" remains.)
8. Repeat steps 4 ~ 7 for other items.
9. Press [▲] to skip back to the setup screen (or press [SETUP]).

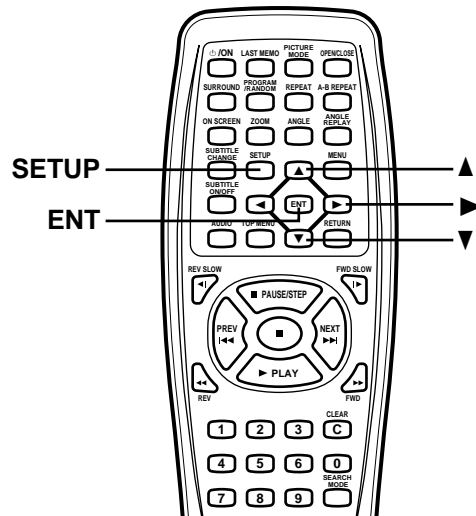

96kHz LPCM (96kHz Liner Pulse Code Modulation):

If your amplifier is available for 96kHz sampling, select "96kHz LPCM". If not, select "48kHz LPCM".

Notes:

- When "48kHz LPCM" is set, there are 48kHz LPCM audio signals from the AUDIO OUT jacks, not 96kHz LPCM audio signals.
- When playing back the DVD video disc which recorded with 96kHz LPCM, there is no digital output.
- But playing back the DVD video disc with no copyright protection, the sound is original recorded sound.

Dolby Digital:

If your amplifier has Dolby Digital Decoder, select "BitStream". If not, select "LPCM".

DTS:

If your amplifier has DTS Decoder, select "On". If not, select "Off".

MPEG (Moving Picture Expert Group):

If your amplifier has MPEG2 Decoder, select "BitStream". If not, select "LPCM".

Setting Parental

1. Press [SETUP] in the stop mode.
The setup screen appears.

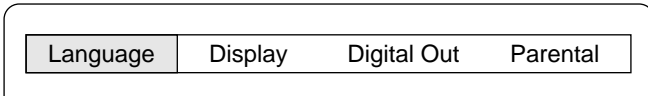

2. Press [▶] to select "Parental".

3. Press [ENT].
"Parental" screen appears.

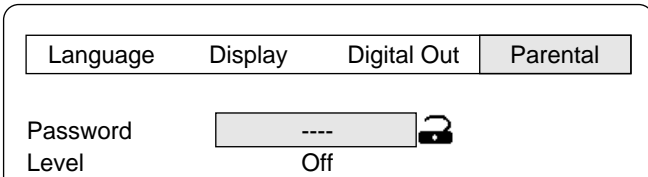

4. Press [▼] to skip "Password ----" and select "Level".



5. Press [ENT] repeatedly to select the parental lock level ("Level Off" ~ "Level 8").
Example: To select "Level 1"

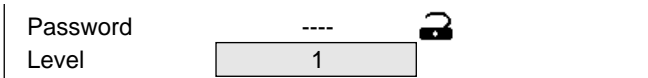

6. Press [▲] to return to "Password ----".

7. Enter a number in 4 digits.

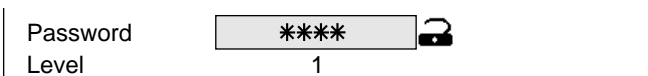

Note:
If you make a mistake, press [CLEAR].

8. Press [ENT].
The password is now set.



Note:
If you do not set it, Parental Control does not work, and it returns to the initial settings.

9. Press [SETUP].
The setup screen disappears.

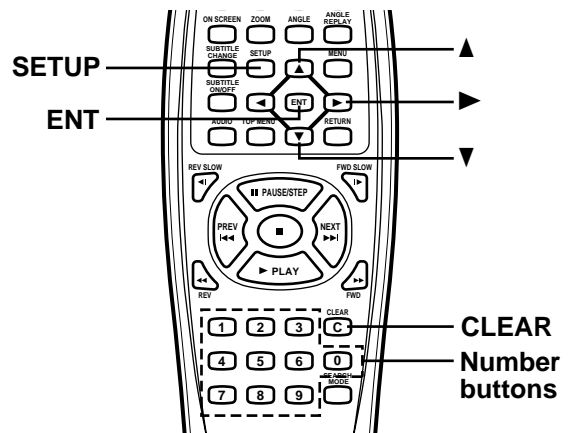

Parental Control

MPAA (Motion Picture Association of America) Guideline is a rating system that provides advanced cautionary information to parent about the content of movie programs.

The parental lock level is equivalent to the following MPAA Rating System.

- Level 7: NC-17 (No one 17 and under admitted)
- Level 6: R (Restricted)
- Level 4: PG-13 (Parents strongly cautioned)
- Level 3: PG (Parental guidance suggested)
- Level 1: G (General audiences)

Some DVD discs contain a restriction level which enables parents to prevent playback of discs by children. This unit is equipped with a password designed to prevent children changing the level.

You cannot play DVD video discs rated higher than the level you selected unless you cancel the parental lock function. For example, when you select level "5", the unit will not play discs with ratings of "6", "7" or "8". The information will appear on the TV screen.

If you forget the password...

Enter "788444" even if 4 digits "----" appears, then press [ENT] to clear the current password. Enter a new password and set the parental lock level again.

Note:
DVD video discs may or may not respond to the parental lock settings. Make sure this function works with your DVD video discs.

LANGUAGE CODE LIST

Enter the appropriate code number for the initial settings “Audio”, “Subtitle” and “DVD Menu” on page E27.

Code	Abbreviation of the language	Language	Code	Abbreviation of the language	Language	Code	Abbreviation of the language	Language
6565	aa	Afar	7369	ie	Interlingue	8278	rn	Kirundi
6566	ab	Abkhazian	7375	ik	Inupiak	8279	ro	Romanian
6570	af	Afrikaans	7378	in	Indonesian	8285	ru	Russian
6577	am	Amharic	7383	is	Icelandic	8287	rw	Kinyarwanda
6582	ar	Arabic	7384	it	Italian	8365	sa	Sanskrit
6583	as	Assamese	7387	iw	Hebrew	8368	sd	Sindhi
6589	ay	Aymara	7465	ja	Japanese	8371	sg	Sangro
6590	az	Azerbaijani	7473	ji	Yiddish	8372	sh	Serbo-Croatian
6665	ba	Bashkir	7487	jw	Javanese	8373	si	Singhalese
6669	be	Byelorussian	7565	ka	Georgian	8375	sk	Slovak
6671	bg	Bulgarian	7575	kk	Kazakh	8376	sl	Slovenian
6672	bh	Bihari	7576	kl	Greenlandic	8377	sm	Samoan
6673	bi	Bislama	7577	km	Cambodian	8378	sn	Shona
6678	bn	Bengali; Bangla	7578	kn	Kannada	8379	so	Somali
6679	bo	Tibetan	7579	ko	Korean	8381	sq	Albanian
6682	br	Breton	7583	ks	Kashmiri	8382	sr	Serbian
6765	ca	Catalan	7585	ku	Kurdish	8383	ss	Siswati
6779	co	Corsican	7589	ky	Kirghiz	8384	st	Sesotho
6783	cs	Czech	7665	la	Latin	8385	su	Sundanese
6789	cy	Welsh	7678	ln	Lingala	8386	sv	Swedish
6865	da	Danish	7679	lo	Laothian	8387	sw	Swahili
6869	de	German	7684	lt	Lithuanian	8465	ta	Tamil
6890	dz	Bhutani	7686	lv	Latvian, Lettish	8469	te	Telugu
6976	el	Greek	7771	mg	Malagasy	8471	tg	Tajik
6978	en	English	7773	mi	Maori	8472	th	Thai
6979	eo	Esperanto	7775	mk	Macedonian	8473	ti	Tigrinya
6983	es	Spanish	7776	ml	Malayalam	8475	tk	Turkmen
6984	et	Estonian	7778	mn	Mongolian	8476	tl	Tagalog
6985	eu	Basque	7779	mo	Moldavian	8478	tn	Setswana
7065	fa	Persian	7782	mr	Marathi	8479	to	Tonga
7073	fi	Finnish	7783	ms	Malay	8482	tr	Turkish
7074	fj	Fiji	7784	mt	Maltese	8483	ts	Tsonga
7079	fo	Faeroese	7789	my	Burmese	8484	tt	Tatar
7082	fr	French	7865	na	Nauru	8487	tw	Twi
7089	fy	Frisian	7869	ne	Nepali	8575	uk	Ukrainian
7165	ga	Irish	7876	nl	Dutch	8582	ur	Urdu
7168	gd	Scots Gaelic	7879	no	Norwegian	8590	uz	Uzbek
7176	gl	Galician	7967	oc	Occitan	8673	vi	Vietnamese
7178	gn	Guarani	7977	om	(Afan) Oromo	8679	vo	Volapük
7185	gu	Gujarati	7982	or	Oriya	8779	wo	Wolof
7265	ha	Hausa	8065	pa	Punjabi	8872	xh	Xhosa
7273	hi	Hindi	8076	pl	Polish	8979	yo	Yoruba
7282	hr	Croatian	8083	ps	Pashto, Pushto	9072	zh	Chinese
7285	hu	Hungarian	8084	pt	Portuguese	9085	zu	Zulu
7289	hy	Armenian	8185	qu	Quechua			
7365	ia	Interlingua	8277	rm	Rhaeto-Romance			

TROUBLESHOOTING GUIDE

If you have followed the instructions and are having difficulty operation the unit, locate the SYMPTOM in the left column below. Check the corresponding POSSIBLE CAUSE and CORRECTIVE ACTION columns to locate and remedy the problem.

SYMPTOM	POSSIBLE CAUSE	CORRECTIVE ACTION
No power.	No power plug connection at the AC wall outlet.	Insert the power plug into the AC wall outlet.
The power is on, but the player does not work.	No disc is loaded.	Load a disc.
No picture.	An unplayable disc is loaded.	Load a playable disc. (Check the disc logo, type, color system and regional code. See page E12.)
	The TV is not set to receive signal from the player.	Select the correct input function on the TV.
	The video cable is not connected.	Connect the video cable into the jack.
	The S-video cable is not connected.	Connect the video cable into the jack.
	"PROGRESSIVE" mode is set.	Select "INTERLACE" mode. (See page E13.)
No sound.	The TV is turned off.	Turn on the TV.
	The audio cables are not connected.	Connect the audio cables into the jacks.
	The audio equipment is turned off.	Turn on the audio equipment connected with the audio cable.
The playback picture is poor.	An unplayable disc is loaded.	Load a playable disc. (Check the disc logo, type, color system and regional code. See page E12.)
"⊗" appears on the TV screen.	The selected function does not operate on the disc now.	The feature or action cannot be completed at this time because: <ul style="list-style-type: none"> • The feature is not available at the moment. • The DVD software restricts it. • The DVD software doesn't support the feature (e.g., angles).
The unit does not start playback.	No disc is loaded.	Load a disc.
	An unplayable disc is loaded.	Load a playable disc. (Check the disc logo, type, color system and regional code. See page E12.)
	The disc is loaded with the label side down.	Load the disc on the disc tray correctly.
	The disc is dirty.	Clean the disc or replace it. (See page E12.)
	"PARENTAL" is set.	Cancel the parental lock function or change the rating level. Reset it after play. (See page E30.)
"No Play" appears on the TV screen.	An unplayable disc is loaded.	Load a playable disc. (Check the disc logo, type, color system and regional code. See page E12.)
	"PARENTAL" is set.	Cancel the parental lock function or change the rating level. Reset it after play. (See page E30.)
	The disc may not have the correct file or data.	Load a playable disc.
The disc tray does not open.	The disc tray may be locked.	Press the ▲ button on the unit until "UN-LOC" appears. (See page E14.)
The FL display on the unit is dark.	The display is set to "Dark".	Reset it to "Normal". (See page E28.)

SYMPTOM	POSSIBLE CAUSE	CORRECTIVE ACTION
The operation or display is not normal.	The unit must be reset.	1. Disconnect the power cord. 2. Reconnect the power cord. 3. Resume operation.
The remote control does not work properly.	The batteries in the remote control are weak, or installed incorrectly.	Check the battery polarity (+ or -). Replace the batteries. (See page E4.)
	The remote control is not aimed at the remote sensor window.	Aim the remote control at the remote sensor window. (See page E4.)

SERVICING:

Should this product require service, refer to the SANYO AUDIO/DVD limited warranty.

If you do not have a convenient SANYO service station nearby, contact the SANYO dealer where you purchased the unit. Be sure to give the model number and explain the problem. The dealer will advise you how to obtain service.

MAINTENANCE

WARNING:

FOR YOUR PERSONAL SAFETY, BE SURE TO DISCONNECT THE AC POWER CORD BEFORE PROCEEDING WITH ANY MAINTENANCE OR CLEANING.

Cleaning the cabinet

Use a clean soft cloth moistened with plain lukewarm water and wrung dry. Never use benzol, benzene or other strong chemical cleaners since these could damage the finish of your unit. It is important that no liquid reaches the inside of the unit.

SPECIFICATIONS

Type:

DVD Video player

Signal format:

NTSC color

Laser:

Semiconductor laser, wavelength 650 nm/790 nm

Frequency range (digital audio):

4 Hz to 44 kHz (DVD fs: 96 kHz)

Signal to noise ratio:

More than 105 dB

Harmonic distortion (digital audio):

0.003 %

Wow and flutter:

Below measurable level

Outputs:

S-VIDEO OUT:

Y: 1.0 V_{p-p} (75 Ω)

C: 0.286 V_{p-p} (75 Ω)

COMPONENT VIDEO OUT:

Y: 1.0 V_{p-p} (75 Ω)

PB: 0.7 V_{p-p} (75 Ω)

PR: 0.7 V_{p-p} (75 Ω)

AUDIO OUT:

R: 2 V rms

L: 2 V rms

VIDEO OUT:

1.0 V_{p-p} (75 Ω)

DIGITAL OUT:

Optical

Power requirements:

AC 120 V, 60 Hz

Power consumption:

11 Watts

Dimensions (W x H x D):

Approx. 14.2" x 2.2" x 9.8" (360 x 55 x 250 mm)

Weight:

Approx. 4.3 lbs (1.95 kg)

IMPORTANT INFORMATION

Because its products are subject to continuous improvement, SANYO reserves the right to modify product designs and specifications without notice and without incurring any obligation.

THE SANYO COMFORT WARRANTY AUDIO/VIDEO PRODUCTS

WARRANTY APPLICATION

New, unused Sanyo Audio/Video products purchased through a Sanyo authorized dealer in Canada are warranted against manufacturing defects in materials and workmanship for **ONE YEAR** from the date of purchase by the original retail purchaser. This warranty only applies in favor of the original retail purchaser of the warranted product.

SANYO CANADA INC.'S RESPONSIBILITY

During the warranty period, SANYO Canada Inc. will repair, or at our option, replace an Audio/Video product which shows evidence of a manufacturing defect in materials or workmanship. Replacement PARTS are warranted for the remaining portion of the warranty period.

WHAT IS NOT COVERED

- (a) Products purchased outside Canada.
- (b) Products purchased in a used condition.
- (c) Problems due to product set-up and installation.
- (d) Adjustments that are outlined in the Operating Manual.
- (e) Accessory items including antenna, batteries, cassette tapes, cables, etc.
- (f) Damage in or due to transportation.
- (g) Damage due to improper maintenance, improper wiring, accident, abuse, misuse or negligence.
- (h) Damage caused by lightning and power surges.

ORIGINAL RETAIL PURCHASER'S RESPONSIBILITY

You, the original retail purchaser, must present your original, dated bill-of-sale together with this warranty to SANYO Canada Inc. or to an authorized Sanyo Service Depot when you make a claim under this Warranty.

You, the original retail purchaser, are responsible for any costs of TRANSPORTING the product to and from SANYO Canada Inc. or an authorized Sanyo Service Depot. You also are responsible for the cost of any MAINTENANCE necessary in respect of the product.

WARRANTY BECOMES VOID

This warranty becomes void if the product's serial numbers are altered or removed or if any repair to the product is made other than by SANYO Canada Inc. or by an authorized Sanyo Service Depot.

LIMITATIONS

- (a) SANYO Canada Inc. reserves the right to change or improve the design of the model of the product warranted hereunder without incurring any obligation to make any modifications to or to install any improvement in or on the product.
- (b) In no event shall SANYO Canada Inc. or any of its Authorized Dealers be liable for special or consequential damage arising from the use of this product.

STATUTORY WARRANTIES

The above provisions do not preclude the operation of any applicable provincial statute which in certain circumstances may not allow some of the limitations and exclusions described in this Warranty. Where any terms of this Warranty are prohibited by such a statute, they shall be deemed null and void but the remainder of this warranty shall remain in effect.

HOW TO OBTAIN WARRANTY SERVICE

Please contact the Sanyo Authorized Dealer from whom the product was purchased, or contact us directly at:

SANYO Canada Inc.
1-300 Applewood Cres.
Concord, Ont. L4K 5C7
(905) 760-9944
1-800-263-2244

<http://www.sanyocanada.com>

(R12)



SANYO Canada Inc.
Printed in China